



Decorative profiles *for your interior*

---

COLLECTION 2019



MARDOM  
DECOR

MARDOM  
DECOR

- 05 | O firmie  
About us  
Über uns  
О нас
- 06 | Legenda  
Legend  
Legende  
легенда
- 08 | Mardom Decor Premium
- 09 | Mardom Decor Atelier
- 11 | Listwy karniszowe  
Curtain profiles  
Gardinenleisten  
Профиль для штор
- 15 | Listwy podłogowe  
Skirting  
Sockelleisten  
плинтусы
- 25 | Profile ścienne gładkie  
Plain panel mouldings  
Glatte Wandprofile  
Настенные гладкие профили
- 33 | Profile ścienne ornamentacyjne  
Ornamented panel mouldings  
Dekorative Wandprofile  
Настенные декоративные профили
- 35 | Listwy sufitowe gładkie  
Plain cornice mouldings  
Glatte Deckenleisten  
Потолочные гладкие панели
- 43 | Listwy sufitowe ornamentacyjne  
Ornamented cornice mouldings  
Dekorative Deckenleisten  
Потолочные декоративные панели
- 47 | Listwy oświetleniowe  
Lighting mouldings  
Lichtleisten  
Карниз подсветкой
- 54 | Narożniki  
Corners  
Ecken mit Wandleisten  
Угловые элементы
- 56 | Rozety  
Ceiling roses  
Rosetten  
Розетки
- 60 | Kolumny  
Columns  
Säulen  
колонны
- 62 | Półkolumny  
Half Columns  
Halbsäulen  
полуколонны
- 64 | Pilastry  
Pilasters  
Pilaster  
пилястры
- 68 | Elementy dekoracyjne  
Decorative elements  
Zierelemente  
Орнаменты
- 70 | Obrazowania  
Frames  
Türumrandungen  
дверное обрамление
- 73 | Akcesoria  
Accessories  
Zubehör  
Аксессуары
- 77 | Materiały marketingowe  
Marketing materials  
Marketing-Materialien  
Материалы для маркетинга
- 78 | Instrukcja montażu  
Installation  
Installation  
монтаж
- 82 | Informacje techniczne  
Technical Info  
Technische Informationen  
техническая информация



1 MD008

2 MDB142

3 MDD414

# MARDOM DECOR

PL

Mardom Decor to firma, która powstała z fascynacji nieograniczonymi możliwościami aranżacji wnętrz, jakie daje zastosowanie sztukaterii. Kreujemy unikalne, zgodne z trendami wzory – od nigdy nie wychodzącego z mody minimalizmu, przez nowoczesne akcenty, po klasyczne zdobienia i bogate ornamenty. Jakość – to największy atut sztukaterii Mardom Decor, zachowany dzięki dbałości o każdy szczegół, stosowaniu wysokogatunkowych materiałów i wykorzystywaniu zaawansowanych rozwiązań technologicznych. Oprócz walorów estetycznych, kluczowych w naszej branży, wielką wagę przywiązujemy do jakości obsługi. Zawsze pamiętamy o przyjaznym podejściu do każdego Klienta i Partnera.

Puść wodze fantazji, uwolnij swój potencjał i stwórz wnętrza spełniające Twoje najśmielsze oczekiwania!

DE

Mardom Decor ist eine Firma, die aus der Faszination an den unbegrenzten Möglichkeiten der Innenraumgestaltung durch die Verwendung von Stuckarbeit entstanden ist. Wir kreieren einzigartige Muster, folgend den neuen Trends – angefangen von dem nie aus der Mode kommenden Minimalismus über moderne Akzente bis zu den klassischen Verzierungen und reichen Ornamenten. Die Qualität – ist der größte Vorzug der Mardom Dekor-Stuckarbeiten, die dank der Fürsorge für jedes Detail, der Verwendung hochwertiger Materialien und der Anwendung fortschrittlicher technologischer Lösungen aufrechterhalten wird. Außer den ästhetischen Werten, die in unserer Branche wesentlich sind, legen wir einen großen Wert auf die Qualität der Bedienung. Wir denken immer an eine freundliche Herangehensweise an jeden Kunden und Geschäftspartner.

Lassen Sie der Phantasie freien Lauf, entfalten Sie Ihre Fähigkeiten und erschaffen sie Innenräume, die Ihre mutigsten Erwartungen erfüllen!

EN

Mardom Decor is founded on fascination with the unlimited possibilities given to interior design by the use of stucco-work. Mardom Decor creates inimitable and upto-the-minute designs which can feature elements of the eternally fashionable minimalism, or alternatively, can include classical decorations and opulent ornamentation. Product quality – the greatest asset of Mardom Decor's stuccowork – is maintained thanks to unmatched attention to detail, and the use of premium-grade materials and the most advanced technological solutions. In addition to aesthetic values, which are of key importance in our sector, we place great emphasis on customer service. Consequently, we always have an accessible and cordial approach to our clients and business partners.

Let your imagination soar, release your potential and create interiors which surpass all your expectations!

RU

MardomDecor – это фирма, которая занимается отделкой интерьеров и производством штукатурки. Мы производим уникальные образцы, следуя трендам. Начиная от минимализма, который никогда не выходит из моды, до современных акцентов с классическими элементами декорирования и богатыми орнаментами. Качество – это основное преимущество штукатурки MardomDecor. Качество соблюдается благодаря заботе о каждой детали, использованию высококачественных материалов и технологических решений. Мы ценим не только эстетику, которая является ключевой в нашей отрасли. Особое внимание мы уделяем качеству обслуживания. Мы всегда помним об индивидуальном подходе к каждому клиенту и партнеру.

Дайте волю фантазии, реализуйте свой потенциал и создайте интерьер, отвечающий самым смелым Вашим ожиданиям!

PL

**PolyForce®**

Produkty wykonane z PolyForce® – bardzo trwałego, ekologicznego materiału o wysokiej gęstości, odpornego na uszkodzenia mechaniczne.

**ProFoam®**

Produkty wykonane z ProFoam® – twardego i jednocześnie lekkiego materiału o gęstości umożliwiającej tworzenie ostrych i głębokich zdobień.

**SupremeSatin®**

Na specjalne życzenie produkt jest dodatkowo pokrywany ekskluzywnym lakierem SupremeSatin®, zapewniającym satynową głębię, śnieżną biel i idealną gładkość. Z powłoki w łatwy sposób można usunąć wszelkie zanieczyszczenia.



Możliwość malowania. Produkt pokryty specjalną powłoką zabezpieczającą o właściwościach wygładzających, wodoodpornych oraz ułatwiających absorpcję farby.

**Flex**

Produkty dostępne w wersji elastycznej, przeznaczone do stosowania na półokrągłych powierzchniach. Listwy podłogowe Flex mają długość 200 cm. Listwy ścienne oraz sufitowe Flex mierzą 235 cm.

**LED**

Produkty dedykowane do stosowania z oświetleniem LED.

EN

Products made of PolyForce® – a very durable, ecological material with high density and resistance to mechanical damage.

Products made of ProFoam® – a hard yet lightweight material with a density enabling the creation of sharp and deep adornments.

On special request, the product is additionally coated with exclusive SupremeSatin® lacquer, providing satin depth, snow white and perfect smoothness. It is easy to remove any impurities from the coating.

Can be painted. The product is covered with a special protective coating, making it smooth, water resistant, and allowing easy absorption of paint.

Products available in the flexible version, intended for use on half-rounded surfaces. The Flex skirting boards have a length of 200 cm. The Flex panel mouldings and cornice mouldings have a length of 235 cm.

Products designed for use with LED lighting.

DE

Produkte sind hergestellt aus PolyForce® – einem sehr haltbaren Material mit hoher Dichte, das gegen mechanische Beschädigungen beständig ist.

Produkte sind hergestellt aus ProFoam® – einem harten und zugleich leichten Material mit einer Dichte, die die Bildung von präzisen, scharfkantigen und vertieften Verzierungen ermöglicht.

Auf speziellen Wunsch wird das Produkt mit dem exklusiven Lack SupremeSatin® überzogen, der die Tiefe der satinierten Oberfläche, eine schneeweiße Farbe und ideale Glätte gewährleistet. Allerlei Verschmutzungen lassen sich leicht von dem Überzug entfernen.

Die Möglichkeit des Bemalens. Das Produkt ist mit einer speziellen absichernden Schicht mit glättenden, wasserabweisenden und die Absorption der Farbe erleichternden Eigenschaften überzogen.

Die in elastischer Version erhältlichen Produkte sind für den Einsatz auf halbkreisförmigen Flächen bestimmt. Fußbodenleisten Flex haben eine Länge von 200 cm. Wand- und Deckenleisten Flex messen 235 cm.

Die Produkte sind für die Verwendung mit der LED-Beleuchtung bestimmt.

RU

Продукция изготовлена из PolyForce® – очень прочного материала с высокой плотностью, устойчивого к механическим повреждениям.

Продукция изготовлена из ProFoam® – прочного и одновременно легкого материала с плотностью, позволяющей создавать острые и глубокие декоративные элементы.

По специальному заказу продукт дополнительно покрывается эксклюзивным лаком SupremeSatin®, обеспечивающим глубину, белизну и идеальную гладкость. Со слоя легко можно устранить все загрязнения.

Возможность покраски. Продукт покрыт специальным защитным слоем с разглаживающими, водоотталкивающими и улучшающими абсорбцию краски свойствами.

Продукция, доступная в эластичной версии, предназначена для применения на полукруглых поверхностях. Напольные панели Flex имеют длину 200 см. Настенные и потолочные панели Flex – 235 см.

Продукция предназначена для применения со светодиодным освещением.





1 MDB111

2 MDD413

3 MD258

4 C8031



## MARDOM DECOR *Premium*®

PL

Na specjalne życzenie naszych klientów listwy z kolekcji Elite pokrywamy ekskluzywną powłoką SupremeSatin®. Ten innowacyjny lakier o właściwościach wygładzających, wodoodpornych i ułatwiających absorpcję farby nadaje produktom nieskazitelny wygląd. Największą zaletą powłoki SupremeSatin® jest elegancja listew, które zachwycają satynową głębią, śnieżną bielą i idealną gładkością. Z powłoki w łatwy sposób można usunąć wszelkie zanieczyszczenia, a skład produktu zadowoli zwolenników ekologicznych rozwiązań. Prawdziwy luksus jest teraz na wyciągnięcie ręki.

EN

At the special request of our customers, mouldings from the Elite collection are painted with the SupremeSatin® coating, an exclusive finishing varnish. This innovative varnish with smoothing and waterproof properties facilitates the absorption of paint and gives the products an immaculate appearance. The biggest advantage of the SupremeSatin® coating is the elegance of the mouldings, which impress with their satin depth, snow white colour and perfect smoothness. It's easy to remove any contamination from the surface of the coating and the composition of the product will fully satisfy the supporters of ecofriendly solutions. Genuine luxury is now within your reach.

DE

Auf speziellen Wunsch unserer Kunden beschichten wir die Leisten aus der Kollektion Elite mit SupremeSatin®. Dieser innovative Lack mit glättenden, wasserabweisenden und die FarbabSORption erleichternden Eigenschaften verleiht den Produkten ein makelloses Aussehen. Der größte Vorteil von SupremeSatin® ist die Eleganz der Leisten, die mit der Tiefe der satinierten Oberfläche, ihrer schneeweißen Farbe und perfekter Glätte verführen. Von der Beschichtung der Leiste lassen sich leicht alle Verschmutzungen entfernen und die Zusammensetzung des Produktes kann selbst die größten Umweltfreunde zufriedenstellen. Wahrer Luxus ist jetzt zum Greifen nahe.

RU

По специальному заказу наших клиентов на панели из коллекции Elite наносится покрытие высокого качества SupremeSatin® - эксклюзивный отделочный лак. Эффект, полученный в результате его нанесения, позволяет продукции приобрести безукоризненный вид, что особенно влияет на весь интерьер. Огромным преимуществом покрытия SupremeSatin® является изящество панелей, которые восхищают атласной глубиной, белоснежностью и идеальной гладкостью. С покрытия легко можно устранить различные загрязнения, а состав продукта порадует сторонников экологических решений. Модельная форма панелей позволяет легко выполнить их монтаж, без дополнительного покрытия или защиты. Настоящая роскошь на расстоянии вытянутой руки.





PL

Mardom Decor Atelier jest odpowiedzią na wyjątkowe potrzeby naszych Klientów, dla których opracowujemy oryginalne i innowacyjne projekty. Dajemy Ci możliwość uczestniczenia w tworzeniu niespotykanych produktów, charakteryzujących się unikatowym wzornictwem i kolorystyką. Elastycznie dostosowujemy się do indywidualnych wizji i oczekiwań, tworząc sztukaterię skrojoną na Twoją miarę.

EN

Mardom Decor Atelier responds to the individual needs of our customers for whom we develop original and innovative designs. We offer the possibility of creating unparalleled products with a unique design and colour palette. We aim at adapting to the vision and expectations of the consumers, creating stuccowork tailored to your needs.

DE

Mardom Decor Atelier ist unsere Antwort auf die individuellen Bedürfnisse unserer Kunden, für die wir originelle und innovative Projekte ausarbeiten. Wir bieten Ihnen die Möglichkeit, einmalige Produkte zu kreieren, die sich durch einzigartiges Design und nicht standardmäßige Farbpalette auszeichnen. An die Visionen und Erwartungen unserer Kunden passen wir uns flexibel an, indem wir maßgeschneiderte Stuckdekorationen erschaffen!

RU

Mardom Decor Atelier является ответом на индивидуальные потребности наших клиентов, для которых мы разрабатываем оригинальные и инновационные проекты. Мы предлагаем возможность создать неповторимую продукцию, имеющую уникальный дизайн и цвет и отличающуюся от стандартного предложения. Мы идем навстречу планам и ожиданиям потребителей. Мы помогаем в реализации новаторских проектов и участвуем в процессе создания уникальных образцов и оттенков панелей. Mardom Decor Atelier – продукция, сделанная именно для Вас!

MARDOM  
DECOR *Atelier*<sup>®</sup>



- / Listwy Karniszowe
- / Curtain Profiles
- / Gardinenleisten
- / Профиль для штор



**QL011**  
200 x 9,1 x 13 cm

**PolyForce®** **LED** 

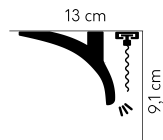

**QL026**  
240 x 9,8 x 4,1 cm

**PolyForce®** **LED** 

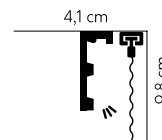

**NEW**  
**QL066**  
240 x 10 x 5 cm

**ProFoam®** **LED** 

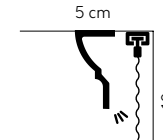

**QL116**  
240 x 12 x 6 cm

**ProFoam®** **LED** 

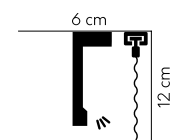

**NEW**  
**QL076**  
240 x 12 x 6 cm

**ProFoam®** **LED** 

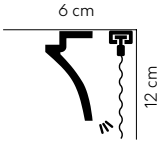

**QL046**  
240 x 12 x 5 cm

**PolyForce®** **LED** 

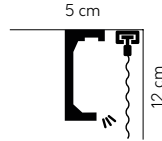

**NEW**  
**QL086**  
240 x 13 x 5 cm

**ProFoam®** **LED** 

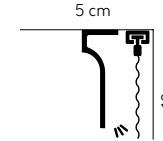

**QL036**  
240 x 14,8 x 4,6 cm

**PolyForce®** **LED** 

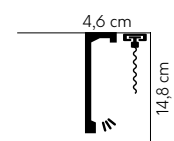



**QL056**  
240 x 18 x 5,5 cm

PolyForce® LED 

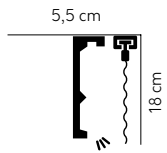

**QL016**  
240 x 18 x 8 cm

ProFoam® LED 

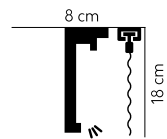





1 MD009

2 MDB117

3 MDD308

/ Listwy podłogowe

/ Skirtings

/ Sockelleisten

/ Плинтусы



**MD235**  
200 x 1,8 x 1,8 cm

PolyForce® SupremeSatin® 

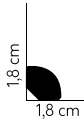

**QL021**  
200 x 2 x 2,5 cm

PolyForce® SupremeSatin® 

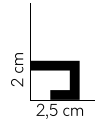

**MD001**  
200 x 2,1 x 2,1 cm

PolyForce® SupremeSatin® 

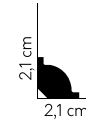

**MD011**  
200 x 4 x 1 cm

PolyForce® SupremeSatin® 

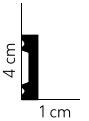

**MD004**  
200 x 4,9 x 1,5 cm

PolyForce® SupremeSatin® 

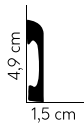

**MD017**  
200 x 6,9 x 1,4 cm

PolyForce® SupremeSatin® 



**QS001**  
240 x 7 x (0,9-2,8) cm

ProFoam® 

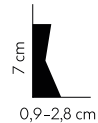

**MD359**  
200 x 7 x 1,6 cm

PolyForce® SupremeSatin® Flex 





**MD234**  
200 x 7,8 x 1,4 cm

PolyForce® SupremeSatin®

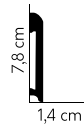

**MD024**  
200 x 8 x 2,7 cm

PolyForce® SupremeSatin®

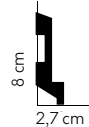

**MD014**  
200 x 8 x 1,4 cm

PolyForce® SupremeSatin®

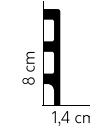

**MD008**  
200 x 8 x 1,7 cm

PolyForce® SupremeSatin®

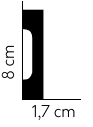

**MD018**  
200 x 8 x 1,3 cm

PolyForce® SupremeSatin® Flex

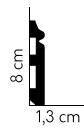

**QL019**  
200 x 8 x 2,5 cm

PolyForce® SupremeSatin®



**QS002**  
240 x 8 x 1,8 cm

ProFoam®

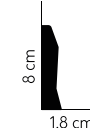

**MD258**  
200 x 8,1 x 1 cm

PolyForce® SupremeSatin®

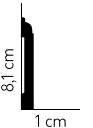



**MD8300**  
200 x 8,2 x 1,7 cm

PolyForce® SupremeSatin® 



Dostępny klips montażowy / Assembly clip available  
/ Erhältlicher Befestigungsclip / Доступная монтажная клипса



**QL007**  
200 x 9,3 x 4,2 cm

PolyForce® SupremeSatin® LED 



**MD094**  
200 x 9,4 x 1,2 cm

PolyForce® SupremeSatin® 

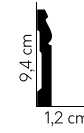

**MD355**  
200 x 9,7 x 2 cm

PolyForce® SupremeSatin® Flex 

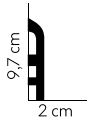

**MD236**  
200 x 9,9 x 1,3 cm

PolyForce® SupremeSatin® 

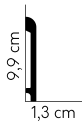

**QL019 + QL021**  
200 x 8 x 2,5 cm + 200 x 2 x 2,5 cm

PolyForce® SupremeSatin® 



**MD016**  
200 x 10 x 2,3 cm

PolyForce® SupremeSatin® 

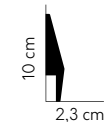

**QS009**  
200 x 10 x 1,6 cm

PolyForce® SupremeSatin® 

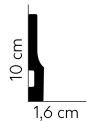





**QS007**  
200 x 10 x 1,6 cm

PolyForce® SupremeSatin®

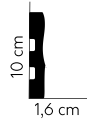

**MD009**  
200 x 10 x 1,7 cm

PolyForce® SupremeSatin®

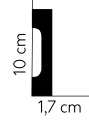

**MD013**  
200 x 10 x 1 cm

PolyForce® SupremeSatin®

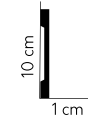

**MD006**  
200 x 10,1 x 2,3 cm

PolyForce® SupremeSatin®



**MD363**  
200 x 10,6 x 2,3 cm

PolyForce® SupremeSatin®

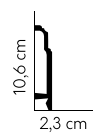

**MD354**  
200 x 10,7 x 1,1 cm

PolyForce® SupremeSatin®

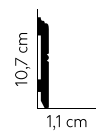

**QS004**  
200 x 10,8 x 1,5 cm

PolyForce® SupremeSatin®



**MD025**  
200 x 11 x 2,7 cm

PolyForce® SupremeSatin®





MD005  
200 x 11 x 2,2 cm

PolyForce® SupremeSatin®



MD356  
200 x 11 x 1,5 cm

PolyForce® SupremeSatin® Flex

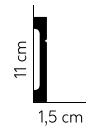

MD358  
200 x 11,7 x 1,4 cm

PolyForce® SupremeSatin® Flex



MD095  
200 x 12 x 1,5 cm

PolyForce® SupremeSatin®

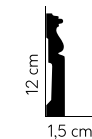

QS003  
200 x 12,8 x 1,8 cm

PolyForce® SupremeSatin®



QL014  
200 x 13 x 4 cm

PolyForce® SupremeSatin® LED



QS011  
200 x 13,5 x 4 cm

PolyForce® SupremeSatin®



MD360  
200 x 13,7 x 1,8 cm

PolyForce® SupremeSatin® Flex





**MD361**  
200 x 14,4 x 1,5 cm

**PolyForce®** *SupremeSatin®* 

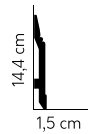

**QS010**  
200 x 14,5 x 2,2 cm

**PolyForce®** *SupremeSatin®* 



**QS008**  
200 x 14,5 x 1,6 cm

**PolyForce®** *SupremeSatin®* 



**QL015**  
200 x 14,8 x 4,2 cm

**PolyForce®** *SupremeSatin®* **LED** 



**QL008**  
200 x 14,8 x 4,3 cm

**PolyForce®** *SupremeSatin®* **LED** 

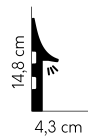

**MD020**  
200 x 19,8 x 1,9 cm

**PolyForce®** *SupremeSatin®* 



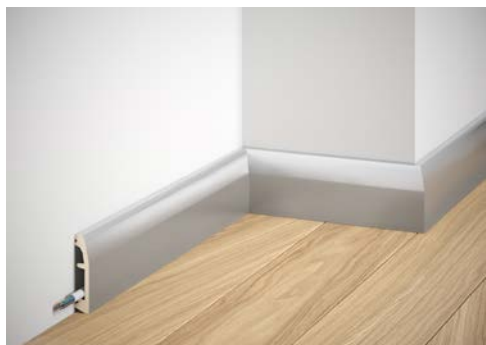

**MD017A**  
200 x 6,9 x 1,4 cm  
PolyForce®

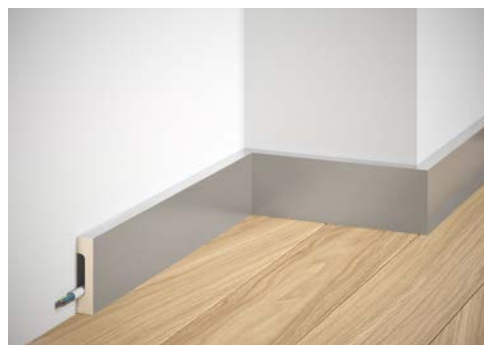

**MD359A**  
200 x 7 x 1,6 cm  
PolyForce®



**MD234A**  
200 x 7,8 x 1,4 cm  
PolyForce®

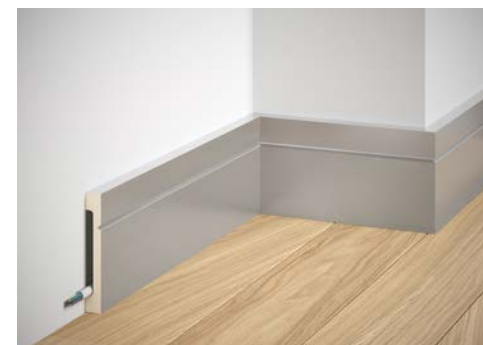

**MD356A**  
200 x 11 x 1,5 cm  
PolyForce®

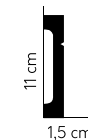

**MD017SS**  
200 x 6,9 x 1,4 cm  
PolyForce®

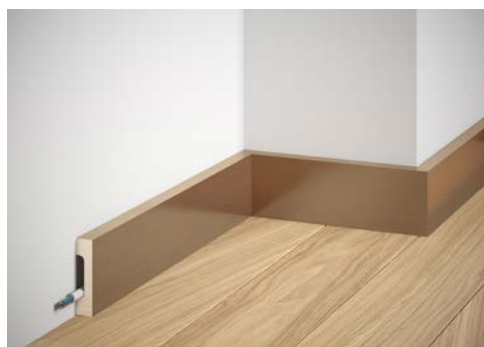

**MD359SS**  
200 x 7 x 1,6 cm  
PolyForce®



**MD234SS**  
200 x 7,8 x 1,4 cm  
PolyForce®

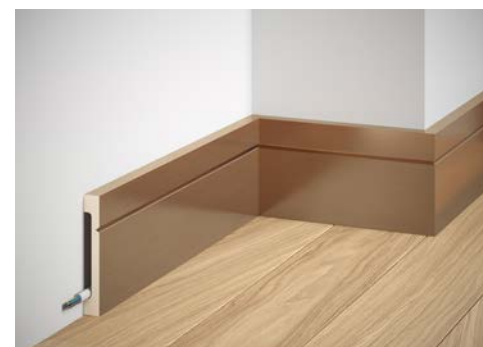

**MD356SS**  
200 x 11 x 1,5 cm  
PolyForce®

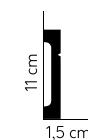

1 MD361 2 MD255 3 MDB102 4 MD007 5 MD088 6 B3047







3

2

1

1 MD361

2 MDD316

3 MDB063

- / Profile ścienne
- / Panel mouldings
- / Wandprofile
- / Настенные профили



**MDD316**  
240 x 1,5 x 0,5 cm  
ProFoam® 

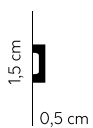

**MD010**  
200 x 1,5 x 1,5 cm  
PolyForce® 

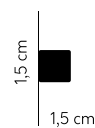

**MD012**  
200 x 2 x 0,5 cm  
PolyForce® 

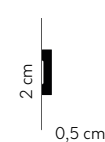

**MDD312**  
240 x 2,2 x 0,9 cm  
ProFoam® 

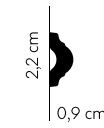

**MD003**  
200 x 2,2 x 1 cm  
PolyForce® 



**MDD413**  
240 x 2,5 x 1,2 cm  
ProFoam® 



**MDD318**  
240 x 3,3 x 1,5 cm  
ProFoam® 

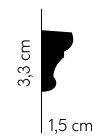

**MD255**  
200 x 3,9 x 2 cm  
PolyForce® 





**MD002**  
200 x 4 x 1,8 cm  
PolyForce®



**MDD332**  
240 x 4,1 x 1,7 cm | Flex 235 cm  
ProFoam® Flex



**MDD325**  
240 x 4,1 x 1,5 cm | Flex 235 cm  
ProFoam® Flex

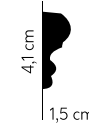

**MDD414**  
240 x 5,1 x 1,1 cm  
ProFoam®



**MDD314**  
240 x 5,2 x 1,7 cm  
ProFoam® Flex



**MDD346**  
240 x 6,1 x 2,5 cm  
ProFoam® Flex



**MDD308**  
240 x 6,5 x 2,1 cm  
ProFoam®

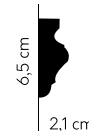

**QL006**  
200 x 7 x 4,2 cm  
PolyForce® LED





MD007  
200 x 7,3 x 2,3 cm

PolyForce® 



MDD412  
240 x 7,5 x 1,8 cm

ProFoam® 



MDD351  
240 x 7,6 x 2,5 cm

ProFoam® Flex 

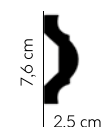

NEW  
MD024  
200 x 8 x 2,7 cm

PolyForce® LED 

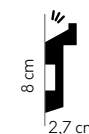

QL019  
200 x 8 x 2,5 cm

PolyForce® LED 

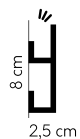

MDD338  
240 x 8 x 2,1 cm

ProFoam® Flex 



MDD339  
240 x 8,1 x 1,9 cm

ProFoam® Flex 

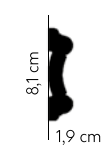

MDD311  
240 x 8,5 x 2,5 cm

ProFoam® Flex 





**MDD305**  
240 x 9 x 2,8 cm  
ProFoam®

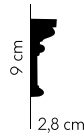

**MD357**  
200 x 9,2 x 2,2 cm  
PolyForce®



**D1541**  
240 x 9,7 x 2,2 cm  
ProFoam®

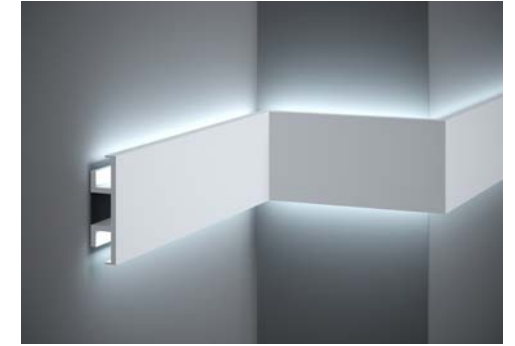
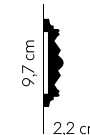

**QL017**  
200 x 10 x 2,5 cm  
PolyForce® LED

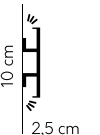

**MD016**  
200 x 10 x 2,3 cm  
PolyForce® LED

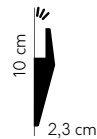

**MDD334**  
240 x 10,1 x 3,3 cm  
ProFoam®



**MDD345**  
240 x 10,2 x 2,4 cm | Flex 235 cm  
ProFoam® Flex



**MDD410**  
240 x 10,8 x 2 cm  
ProFoam®







NEW

**MD025**  
200 x 11 x 2,7 cm

PolyForce® LED

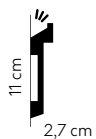

**MDD356**  
240 x 11,4 x 2 cm

ProFoam®



**QS011**  
200 x 13,5 x 4 cm

PolyForce® LED

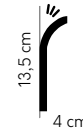

**QL020**  
200 x 15 x 2,5 cm

PolyForce® LED

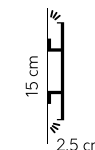

**MDD335**  
240 x 15,5 x 5,4 cm

ProFoam®



**MDD315**  
240 x 22 x 6,4 cm

ProFoam®



**MD237**  
200 x 3 x 3 cm

PolyForce®

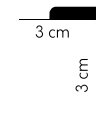

**MDB123**  
240 x 4,1 x 4,1 cm

ProFoam®





1 MD361

2 MD003

3 MDB001



1 MD009

2 MDD312

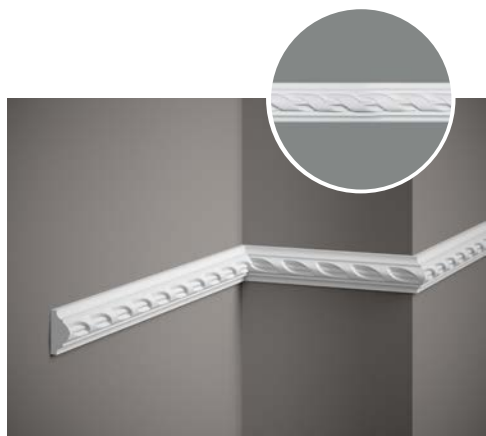

**MDC252**  
240 x 5,4 x 2,3 cm

ProFoam® Flex



**MDC258**  
240 x 5,4 x 2 cm

ProFoam® Flex

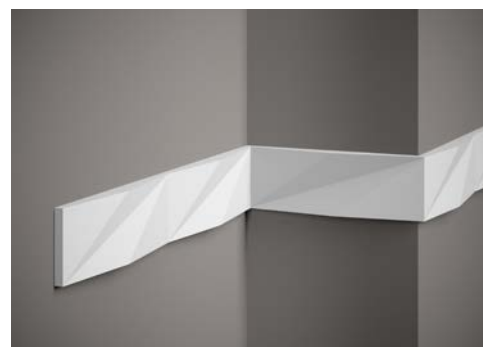

**QC001**  
240 x 7 x 1,8 cm

ProFoam®

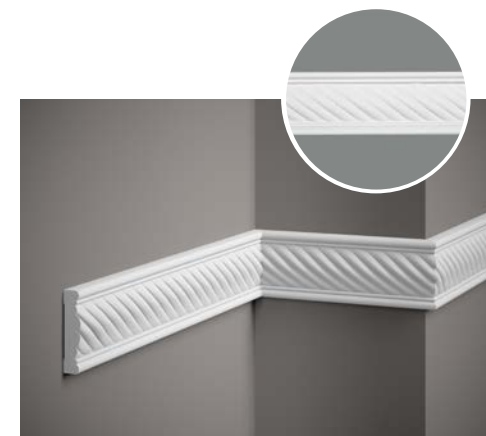

**MDC239**  
240 x 7,5 x 1,5 cm

ProFoam® Flex



**MDC217**  
240 x 7,8 x 1,3 cm

ProFoam® Flex



**MDC250**  
240 x 8,1 x 2 cm

ProFoam® Flex



**MDC236**  
240 x 12,8 x 1,4 cm

ProFoam® Flex

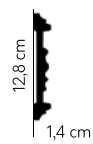





3

4

2

1

1 MD359

2 MD359E

3 MDB117

4 MDD308

- / Listwy sufitowe
- / Cornice mouldings
- / Deckenleisten
- / Потолочные панели





**MDB180**  
240 x 2,5 x 1,5 cm

ProFoam® 

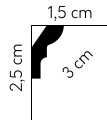

**MDB135**  
240 x 3,2 x 3,2 cm

ProFoam® Flex 

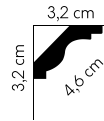

**MDB136**  
240 x 4 x 4 cm

ProFoam® Flex 

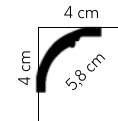

**MDB172**  
240 x 4 x 4 cm

ProFoam® Flex 

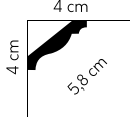

**MDB112**  
240 x 4,4 x 4,4 cm

ProFoam® Flex 

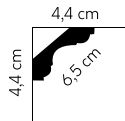

**MDB130**  
240 x 5 x 19 cm

ProFoam® 

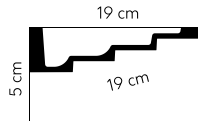

**MDB063**  
240 x 5 x 5 cm

ProFoam® 

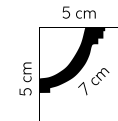

**MDB210**  
240 x 5,1 x 4,8 cm | Flex 235 cm

ProFoam® Flex 

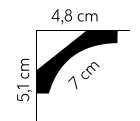



**MDB174**  
240 x 5,2 x 4,9 cm  
ProFoam® 

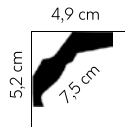

**MD368**  
200 x 5,3 x 5 cm  
PolyForce® 

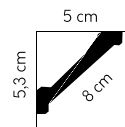

**MDB132**  
240 x 5,5 x 8,7 cm  
ProFoam® 

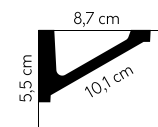

**MDB147**  
240 x 5,5 x 5 cm  
ProFoam® 

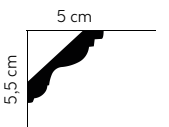

**MDB127**  
240 x 5,5 x 13,5 cm  
ProFoam® 

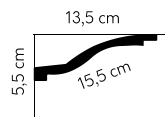

**MDB106**  
240 x 5,7 x 5,7 cm  
ProFoam® Flex 

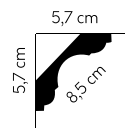

**MDB145**  
240 x 6 x 6 cm | Flex 235 cm  
ProFoam® Flex 

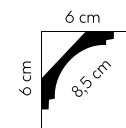

**MDB001**  
240 x 6,7 x 6,7 cm  
ProFoam® 

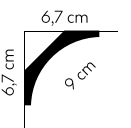



**MDB064**  
240 x 6,8 x 6,4 cm

ProFoam® 

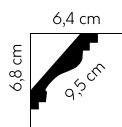

**MDB185**  
240 x 7 x 5,2 cm

ProFoam® Flex 

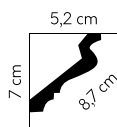

**MDB152**  
240 x 7,6 x 7,6 cm

ProFoam® Flex 

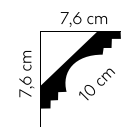

**MDB134**  
240 x 8 x 8 cm

ProFoam® 

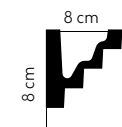

**MDB102**  
240 x 8 x 8,2 cm

ProFoam® Flex 

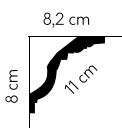

**MDB213**  
240 x 8,1 x 8,1 cm

ProFoam® Flex 

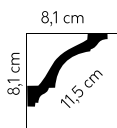

**MDB117**  
240 x 8,5 x 9 cm | Flex 235 cm

ProFoam® Flex 

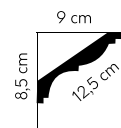

**MDB131**  
240 x 9 x 14 cm

ProFoam® 

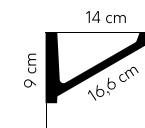



**MDB161**  
240 x 9 x 8,5 cm  
ProFoam® 

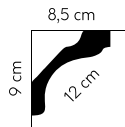

**MDB111**  
240 x 9,2 x 6,2 cm  
ProFoam® 

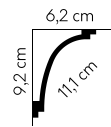

**MDB110**  
240 x 9,2 x 10,6 cm  
ProFoam® 

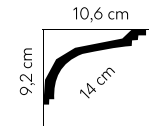

**MDB137**  
240 x 9,6 x 5,5 cm  
ProFoam® 

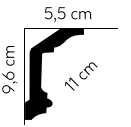

**MDB142**  
240 x 9,9 x 7,6 cm  
ProFoam® 

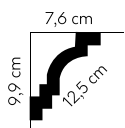

**MDB118**  
240 x 10 x 9,7 cm  
ProFoam® 

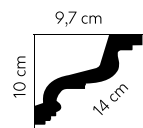

**MDB108**  
240 x 10 x 10 cm | Flex 235 cm  
ProFoam®  Flex 

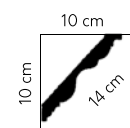

**MDB158**  
240 x 10,5 x 12,5 cm  
ProFoam® 

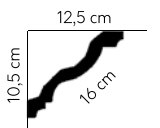



**MDB105**  
240 x 10,8 x 12,2 cm  
ProFoam®

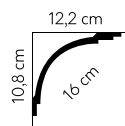

**MDB156**  
240 x 11 x 14,7 cm  
ProFoam®

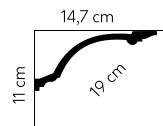

**MDB121**  
240 x 11,6 x 22,4 cm  
ProFoam®

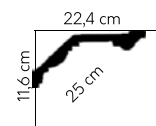

**MDB169**  
240 x 12 x 12,9 cm  
ProFoam®

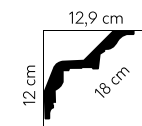

**MDB214**  
240 x 15 x 14,6 cm  
ProFoam®

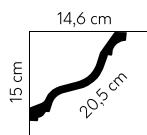

**MDB154**  
240 x 15,4 x 12 cm  
ProFoam®

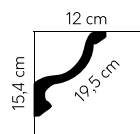

**MDB140**  
240 x 16,5 x 15,3 cm  
ProFoam®

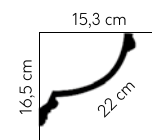

**MDB104**  
240 x 16,8 x 12,2 cm  
ProFoam®

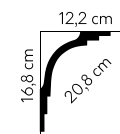



**MDB128**  
240 x 17,2 x 17,4 cm

ProFoam® 

Pasuje do MDA113 / Suitable for the MDA113  
/ Kompatibel mit MDA113 / Подходит для MDA113

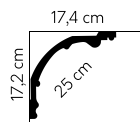

**MDB103**  
240 x 18 x 14,4 cm

ProFoam® 

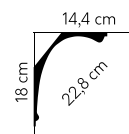

**MDB155**  
240 x 21,6 x 21,6 cm

ProFoam® 

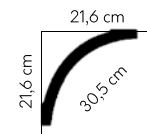





1 MD009

2 MDB172

3 QL016

4 MD006

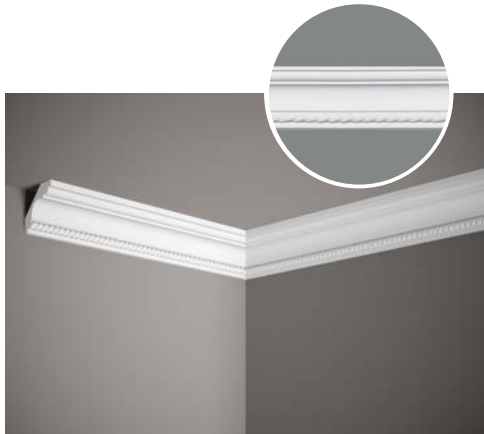

**MDA005**  
240 x 5,8 x 5,8 cm | Flex 235 cm

ProFoam® Flex

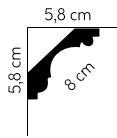

**MDA008**  
240 x 7 x 8,2 cm

ProFoam®

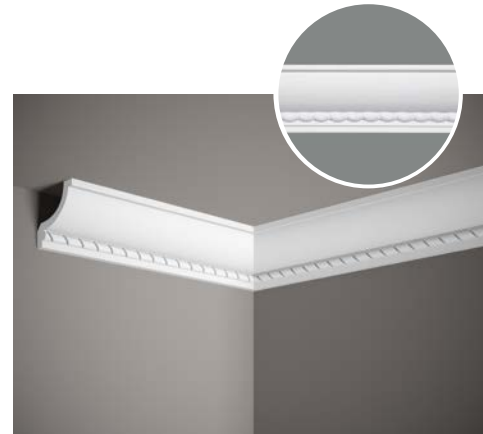
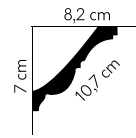

**MDA121**  
240 x 7,4 x 7 cm

ProFoam®

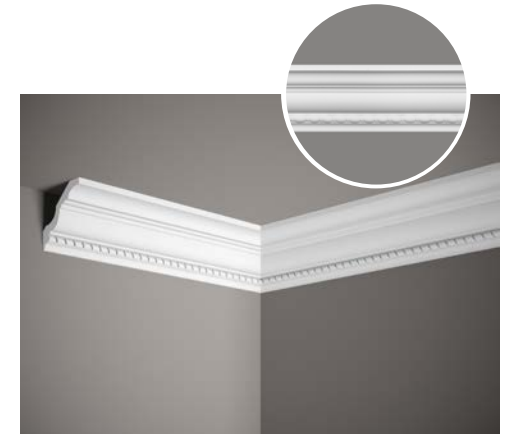
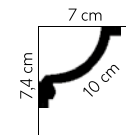

**MDA106**  
240 x 7,5 x 7,5 cm

ProFoam® Flex

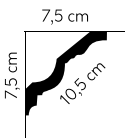

**MDA212**  
240 x 7,8 x 4,4 cm

ProFoam® Flex

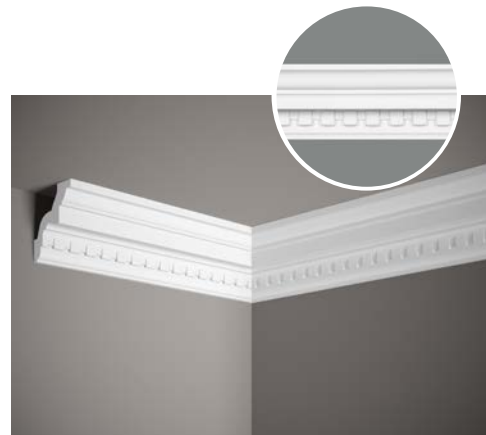
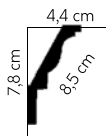

**MDA002**  
240 x 8,6 x 8,2 cm

ProFoam®

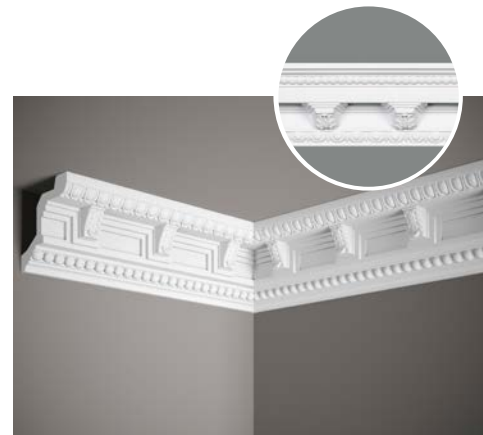
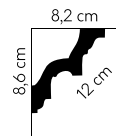

**MDA007**  
240 x 10 x 9,2 cm

ProFoam®

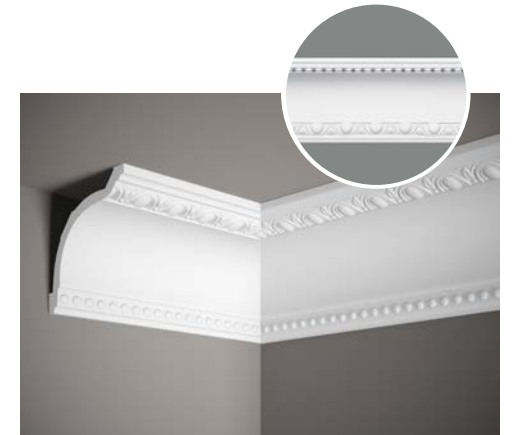
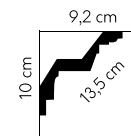

**MDA040**  
240 x 11 x 13,5 cm

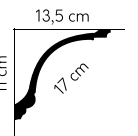

ProFoam® Flex

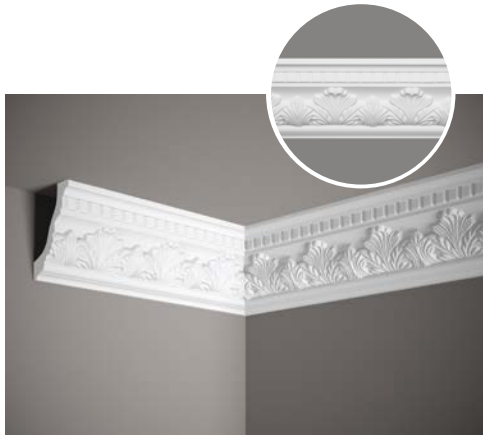



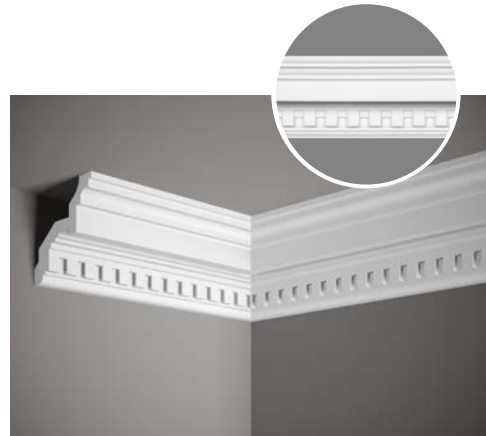
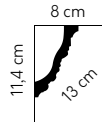

**MDA098**  
240 x 11,4 x 8 cm  
ProFoam® 

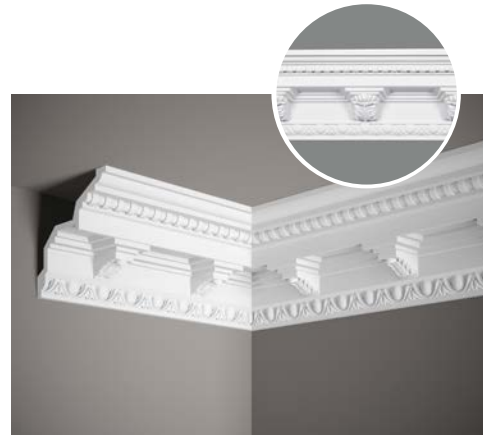
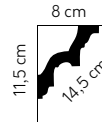

**MDA046**  
240 x 11,5 x 11,5 cm  
ProFoam®  Flex 



**MDA067**  
240 x 13,3 x 13,7 cm  
ProFoam® 

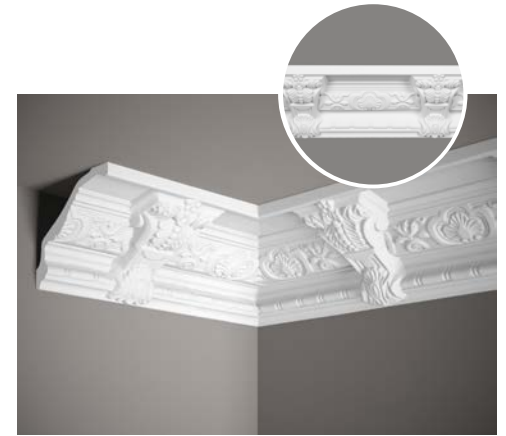
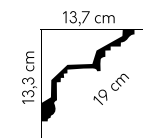

**MDA138**  
240 x 13,3 x 16 cm  
ProFoam® 

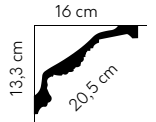

**MDA072**  
240 x 15 x 6,4 cm  
ProFoam® 

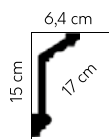

**MDA218**  
240 x 15,3 x 11,8 cm  
ProFoam® 

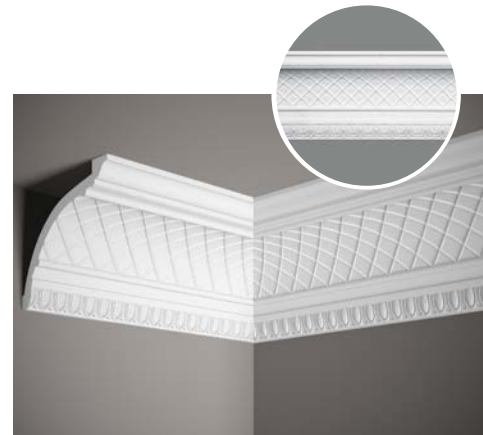
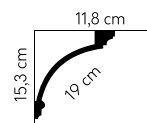

**MDA401**  
240 x 16,9 x 14,1 cm  
ProFoam® 

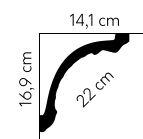

**MDA109**  
240 x 17,1 x 17,8 cm  
ProFoam® 

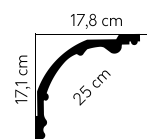

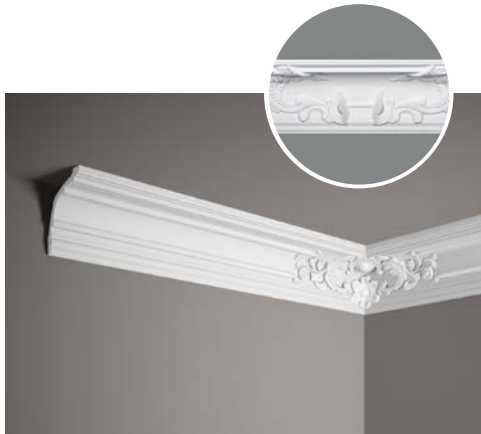

**MDA113**  
240 x 17,1 x 17,8 cm

ProFoam® 

Pasuje do MDB128 / Suitable for the MDB128  
/ Kompatibel mit MDB128 / Подходит для MDB128

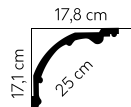

1 MDD312

2 QL026





1 QL007

2 QL006

3 QL002

/ Listwy oświetleniowe

/ Lighting mouldings

/ Lichteisten

/ Карниз подсветкой





**QL007**  
200 x 9,5 x 4,2 cm

PolyForce® SupremeSatin® LED



9,6 cm  
4,2 cm



**QL019 + QL021**  
200 x 8 x 2,5 cm + 200 x 2 x 2,5 cm

PolyForce® SupremeSatin® LED



8 + 2 cm  
2,5 cm



**QL014**  
200 x 13 x 4 cm

PolyForce® SupremeSatin® LED



13 cm  
4 cm



**QL015**  
200 x 14,8 x 4,2 cm

PolyForce® SupremeSatin® LED



14,8 cm  
4,2 cm



**QL008**  
200 x 14,8 x 4,3 cm

PolyForce® SupremeSatin® LED



14,8 cm  
4,3 cm



**QL006**  
200 x 7 x 4,2 cm

PolyForce® LED



7 cm  
4,2 cm



**QL017**  
200 x 10 x 2,5 cm

PolyForce® LED

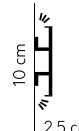

10 cm  
2,5 cm



**QL020**  
200 x 15 x 2,5 cm

PolyForce® LED



15 cm  
2,5 cm



**MD368**  
200 x 5,3 x 5 cm

PolyForce® LED

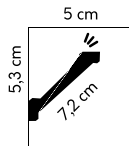

**MD118**  
200 x 7 x 2,7 cm

PolyForce® LED

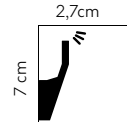

**MDB070**  
240 x 7,2 x 4 cm

ProFoam® LED

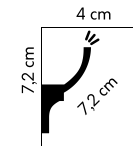

**MD367**  
200 x 7,2 x 7,2 cm

PolyForce® LED

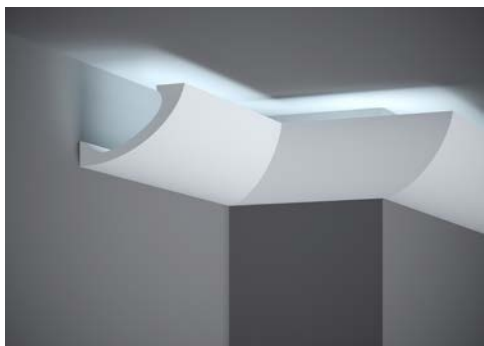
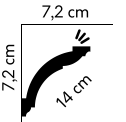

**MD369**  
200 x 7,8 x 11,5 cm

PolyForce® LED

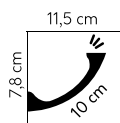

**MDB080**  
240 x 8 x 6 cm

ProFoam® LED

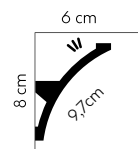

**MD024**  
200 x 8 x 2,7 cm

PolyForce® LED

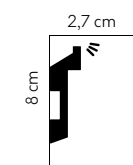

**QL019**  
200 x 8 x 2,5 cm

PolyForce® LED





**QL002**  
200 x 8,5 x 8,5 cm

PolyForce® LED

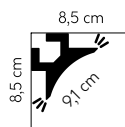

**MD362**  
200 x 8,6 x 17,2 cm

PolyForce® LED

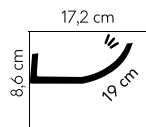

**QL018**  
200 x 9,5 x 2,5 cm

PolyForce® LED

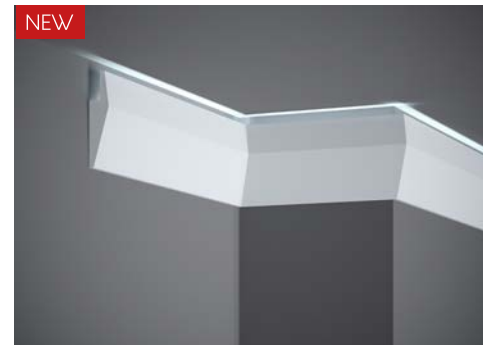
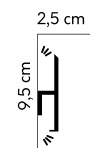

**MD016**  
200 x 10 x 2,3 cm

PolyForce® LED

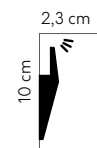

**MDB100**  
240 x 10 x 5 cm

ProFoam® LED

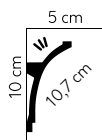

**MD105**  
240 x 10,8 x 12,2 cm

PolyForce® LED

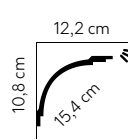

**MD025**  
200 x 11 x 2,7 cm

PolyForce® LED

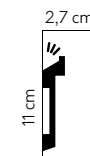

**MDB115**  
240 x 11 x 6 cm

ProFoam® LED

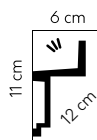

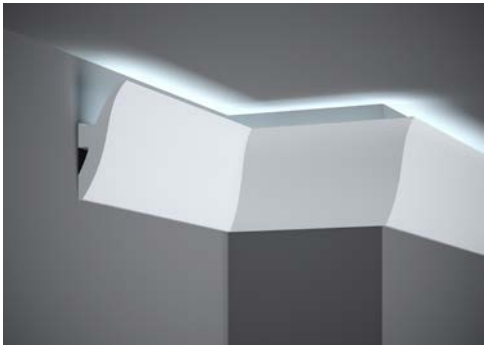

**QL009**  
200 x 12 x 4,7 cm

PolyForce® LED 

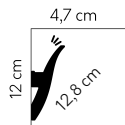

**QL010**  
200 x 12 x 4,2 cm

PolyForce® LED 

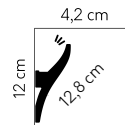

**QL011**  
200 x 13 x 9,41 cm

PolyForce® LED 

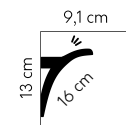

**QL003**  
200 x 13 x 13 cm

PolyForce® LED 

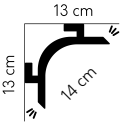

**QS011**  
200 x 13,5 x 4 cm

PolyForce® LED 

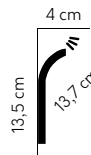

**QL012**  
200 x 13,9 x 10,5 cm

PolyForce® LED 

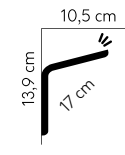

**MDB101**  
240 x 14 x 10,6 cm

ProFoam® LED 

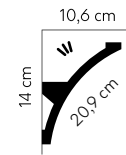

**QL001**  
200 x 14,7 x 14,7 cm

PolyForce® LED 

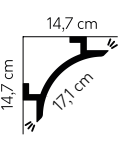



**MDB150**  
240 x 15 x 4 cm

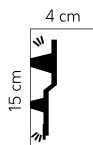

**QL004**  
200 x 15 x 15 cm

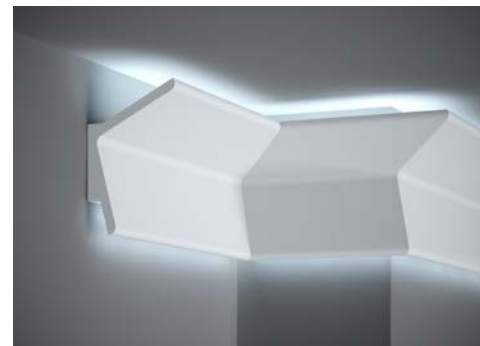
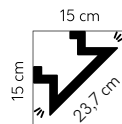

**QL013**  
200 x 15 x 9,7 cm

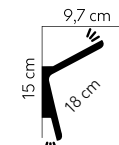

/ Elementy dekoracyjne

/ Decorative elements

/ Zierelemente

/ Орнаменты



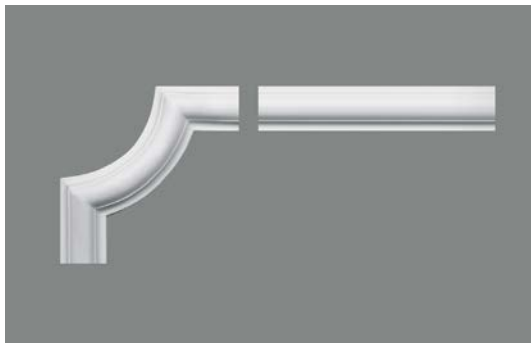

MDD332-13 + MDD332  
15,5 x 15,5 x 2 cm



MDD318-12 + MDD318  
7 x 17 x 1,5 cm

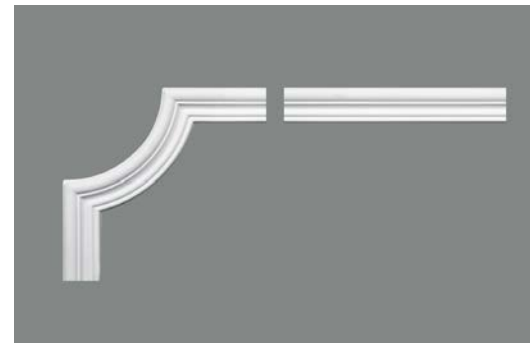

MDD325-12 + MDD325  
23 x 23 x 1,5 cm



MDD308-12 + MDD308  
24 x 24 x 2,1 cm



MDC258-12 + MDC258  
25,5 x 25,5 x 1,9 cm

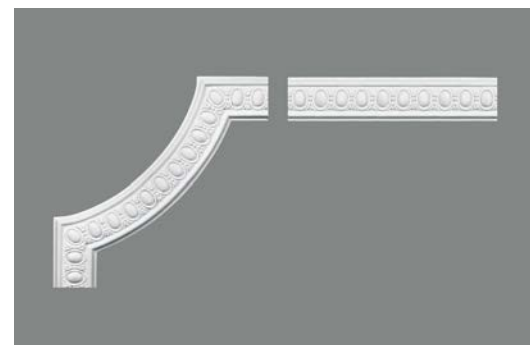

MDC250-12 + MDC250  
41 x 41 x 2 cm



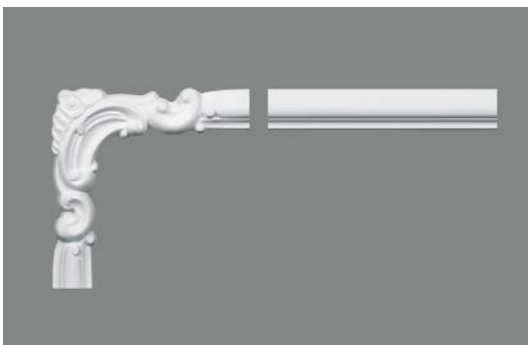

MDD332-11 + MDD332  
21 x 21 x 2 cm



MDC252-11 + MDC252  
24 x 24 x 1,9 cm



MDC258-13 + MDC258  
25,5 x 25,5 x 1,9 cm

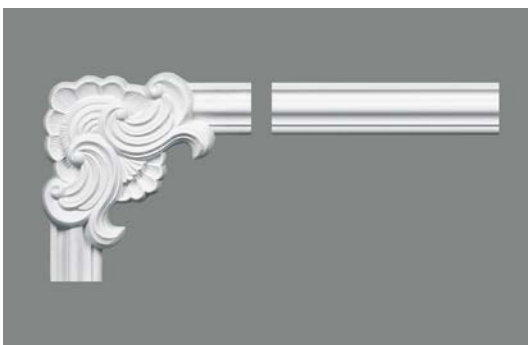

MDD308-11 + MDD308  
27 x 27 x 2,1 cm

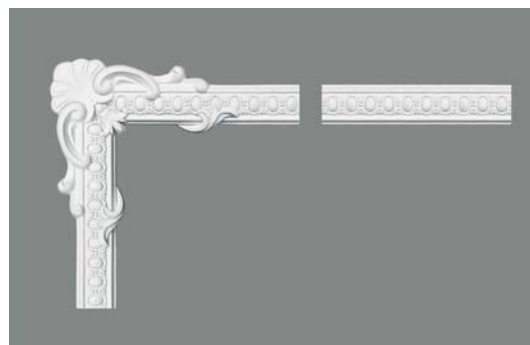

MDC250-11 + MDC250  
50,5 x 50,5 x 2 cm

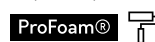

MDD332-12 + MDD332  
23,5 x 11 x 2 cm



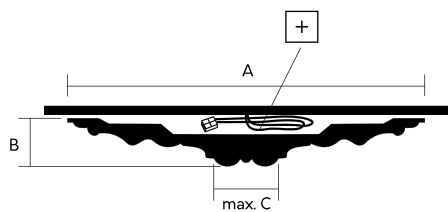

A x B - C (cm)

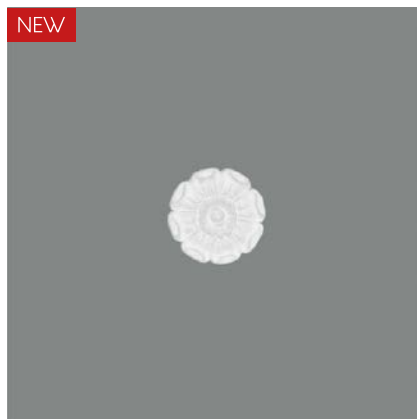

**B3002**  
ø 15,5 x 2,3 cm  
ProFoam®

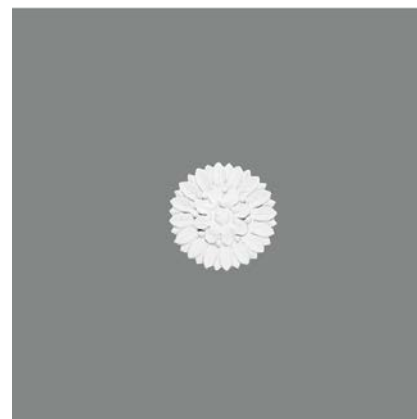

**B3002**  
ø 15,5 x 2,3 cm  
ProFoam®

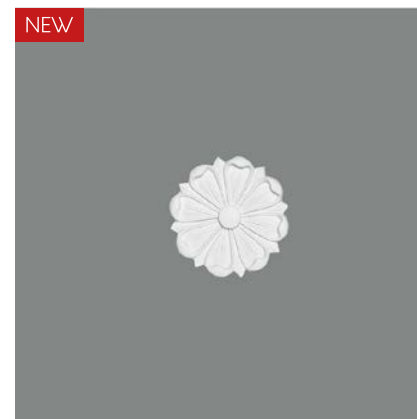

**B3021**  
ø 16 x 1,6 cm  
ProFoam®



**B3014**  
ø 32 x 4 cm  
ProFoam®



**B3030**  
ø 37,5 x 4,6 - 10 cm  
ProFoam®



**B3029**  
ø 38 x 4,5 - 7,5 cm  
ProFoam® 



**B3033**  
ø 48,5 x 5,4 - 14 cm  
ProFoam® 



**QR001**  
 ø 50 x 4 – 15,5 cm  
 ProFoam®



**B3020**  
 ø 51 x 3,5 – 10 cm  
 ProFoam® +



**B3025**  
 ø 53,5 x 4 – 10 cm  
 ProFoam®



**QR002**  
 ø 60 x 5 cm  
 ProFoam® +



**QR005**  
 ø 60 x 5 cm  
 ProFoam® +



**B3047**  
 ø 60 x 7 – 15 cm  
 ProFoam® +



**B3023**  
 ø 60 x 8,5 – 8,5 cm  
 ProFoam® +

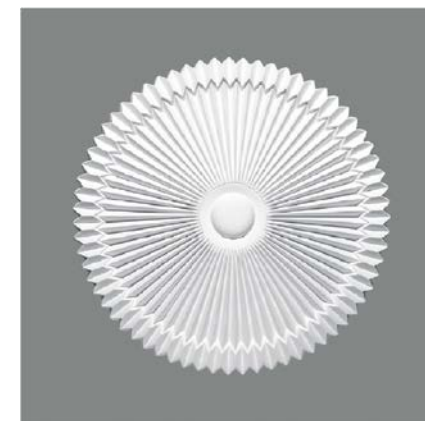

**B3120**  
 ø 61 x 7,6 – 12 cm  
 ProFoam® +



**B3038**  
ø 62 x 4 – 14 cm

ProFoam® +



**B3016**  
ø 65 x 13,6 – 9 cm

ProFoam® +



**B3050**  
ø 67 x 5,3 – 6,5 cm

ProFoam®



**B2050\***  
ø 68,5 x 10 – 15 cm

ProFoam®

\*wklęsta / concave / konkav / вогнутый



**B3049**  
ø 69 x 6 – 13 cm

ProFoam® +



**B2002**  
ø 72 x 12,5 cm

ProFoam®



**B3077**  
ø 77,5 x 4 – 8 cm

ProFoam®



**B3015**  
ø 84 x 6,4 – 15 cm

ProFoam®

NEW



**B2003**  
ø 113 x 21,5 cm

ProFoam®

NEW



**B2004**  
ø 123 x 20 cm

ProFoam® +



H: C1000-2W + C3000W + C5000-4W = 273,2 cm  
 H: C1000-1W + C3000W + C5000-4W = 263 cm

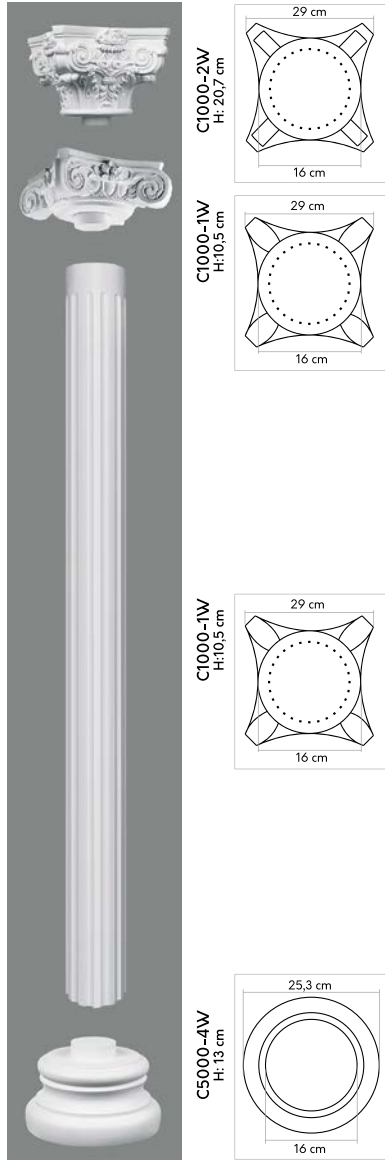

ProFoam®

H: C1000-2W + C4000W + C5000-4W = 276,2 cm  
 H: C1000-1W + C4000W + C5000-4W = 266 cm

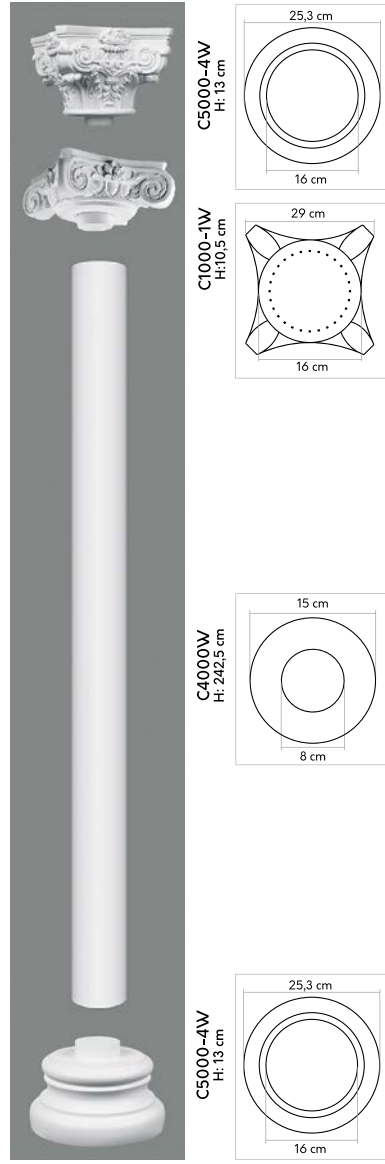

ProFoam®

H: C1001-2W + C3001W + C5001-4W = 278,5 cm  
 H: C1001-1W + C3001W + C5001-4W = 265,5 cm

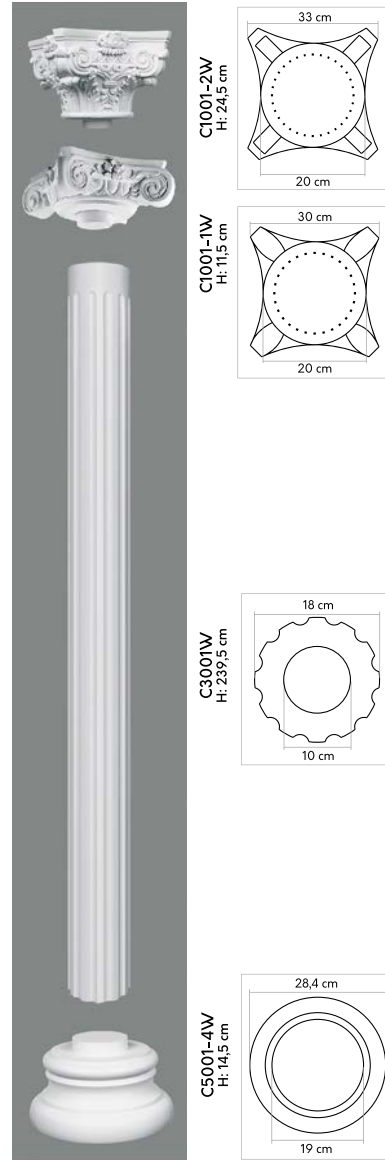

ProFoam®

H: C1001-2W + C4001W + C5001-4W = 281,5 cm  
 H: C1001-1W + C4001W + C5001-4W = 268,5 cm

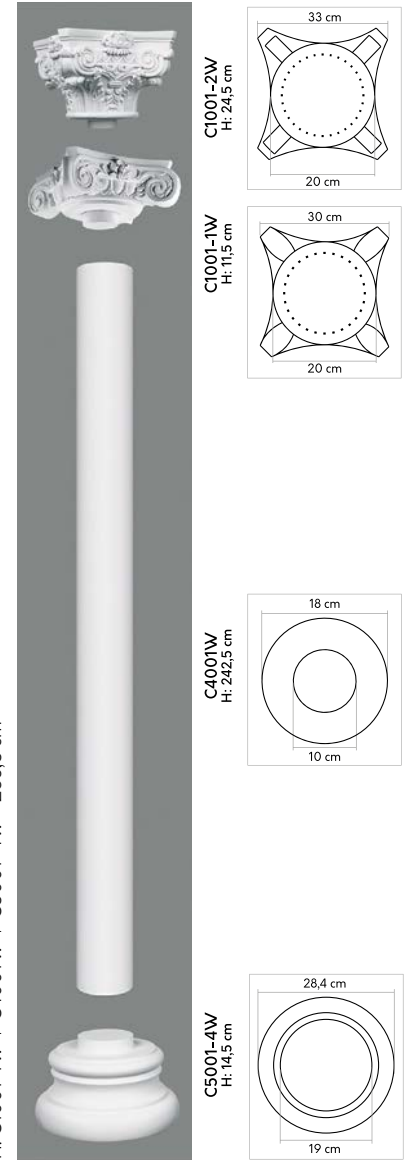

ProFoam®

H: C1002-2W + C3002W + C5002-4W = 281,2 cm  
 H: C1002-1W + C3002W + C5002-4W = 268 cm

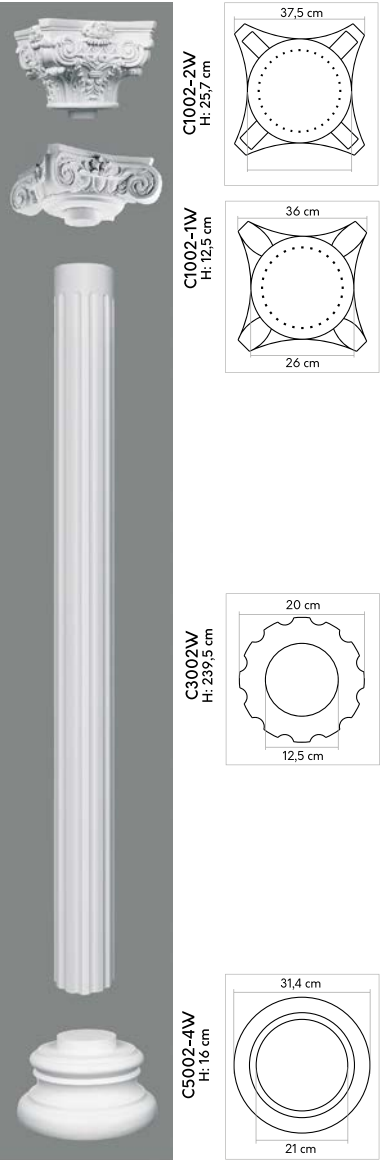

ProFoam®

H: C1002-2W + C4002W + C5002-4W = 284,2 cm  
 H: C1002-1W + C4002W + C5002-4W = 271 cm

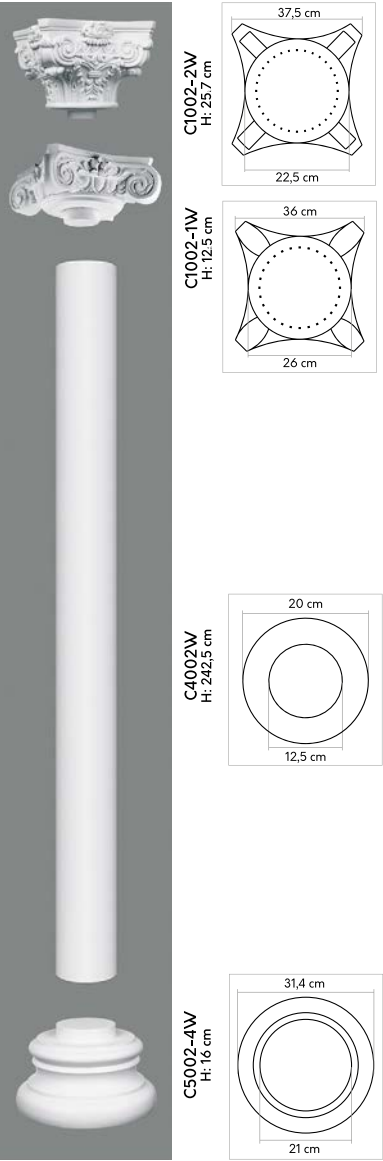

ProFoam®

H: C1000-2H + C3000H + C5000-4H = 273,2 cm  
 H: C1000-1H + C3000H + C5000-4H = 263 cm

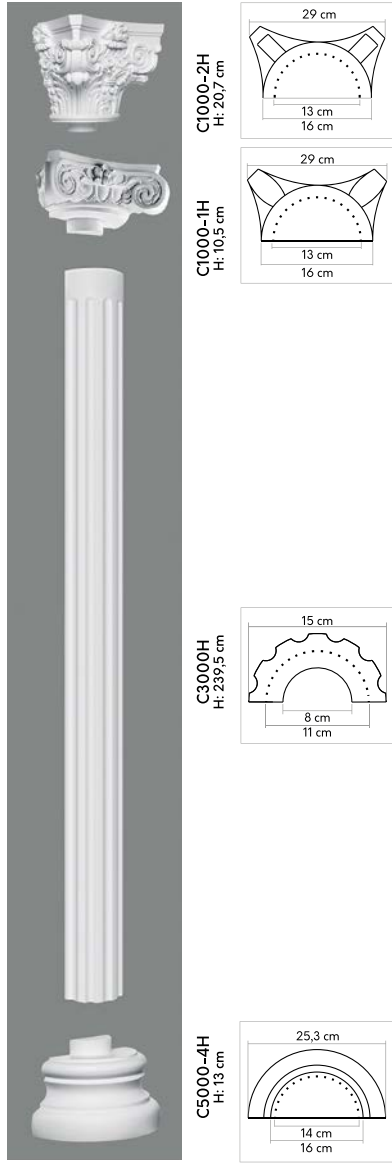

ProFoam®

H: C1000-2H + C4000H + C5000-4H = 276,2 cm  
 H: C1000-1H + C4000H + C5000-4H = 266 cm

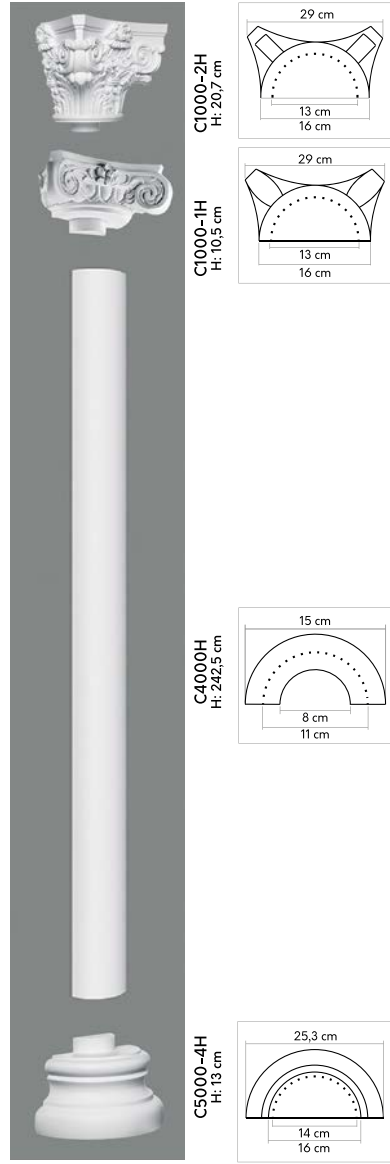

ProFoam®

H: C1001-2H + C3001H + C5001-4H = 278,5 cm  
 H: C1001-1H + C3001H + C5001-4H = 265,5 cm

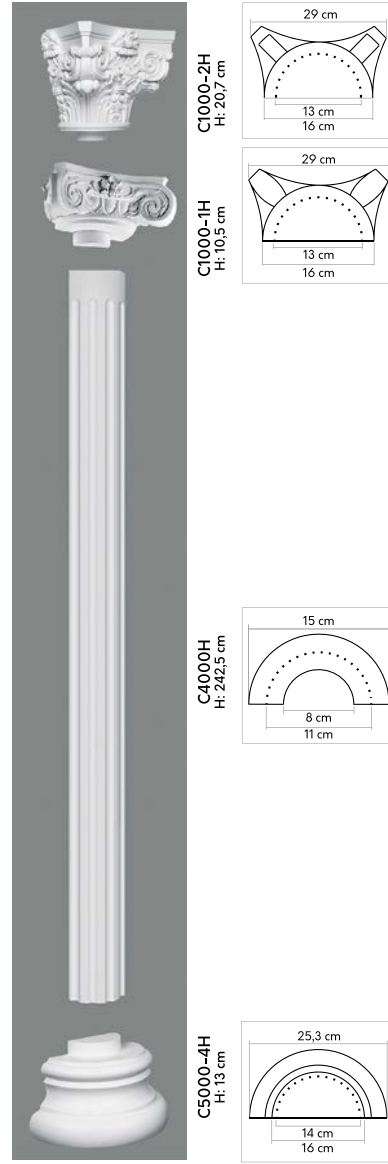

ProFoam®

H: C1001-2H + C4001H + C5001-4H = 281,5 cm  
 H: C1001-1H + C4001H + C5001-4H = 268,5 cm

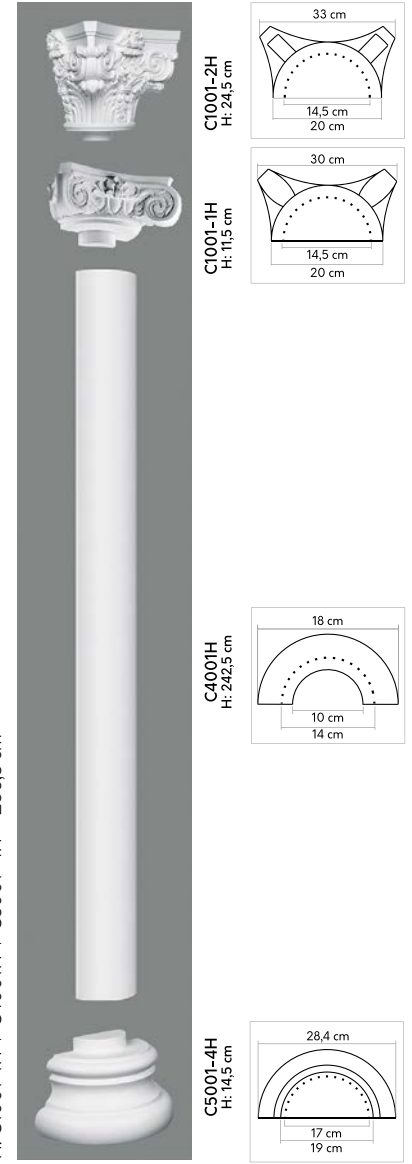

ProFoam®

H: C1002-2H + C3002H + C5002-4H = 281,2 cm  
 H: C1002-1H + C3002H + C5002-4H = 268 cm

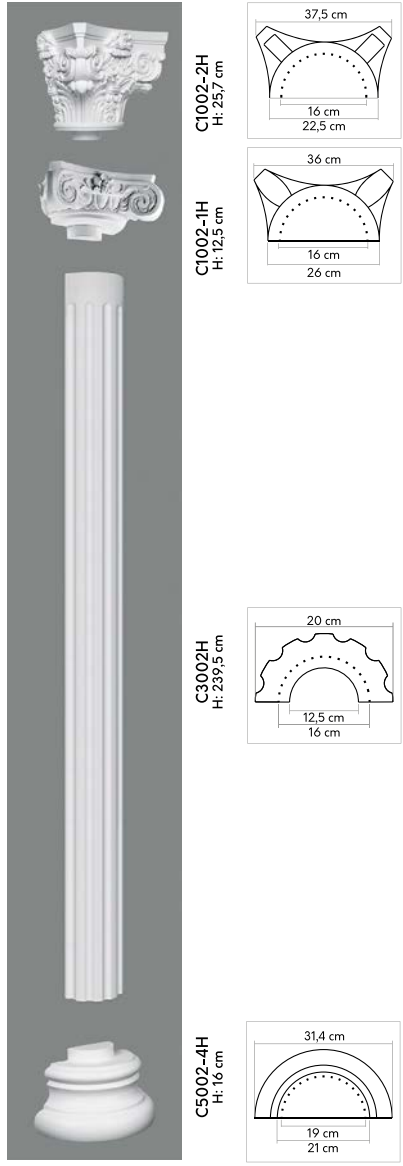

ProFoam®

H: C1002-2H + C4002H + C5002-4H = 284,2 cm  
 H: C1002-1H + C4002H + C5002-4H = 271 cm

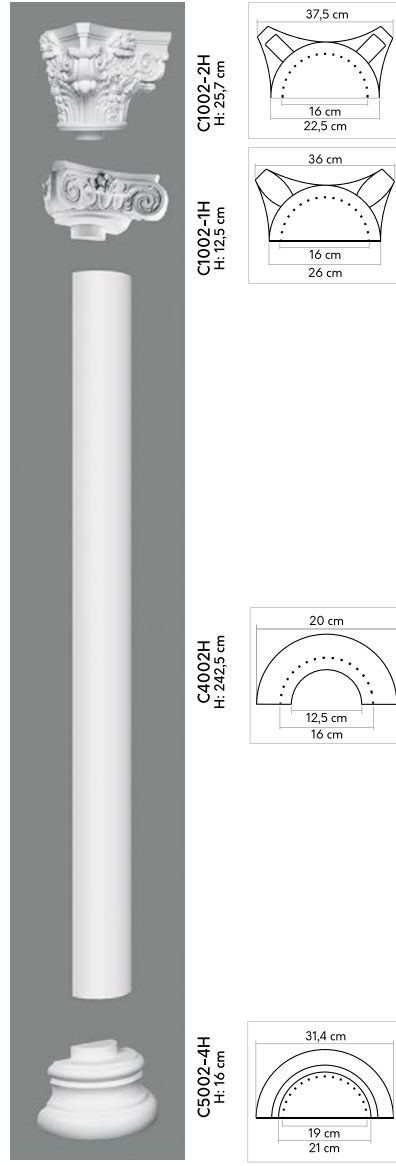

ProFoam®

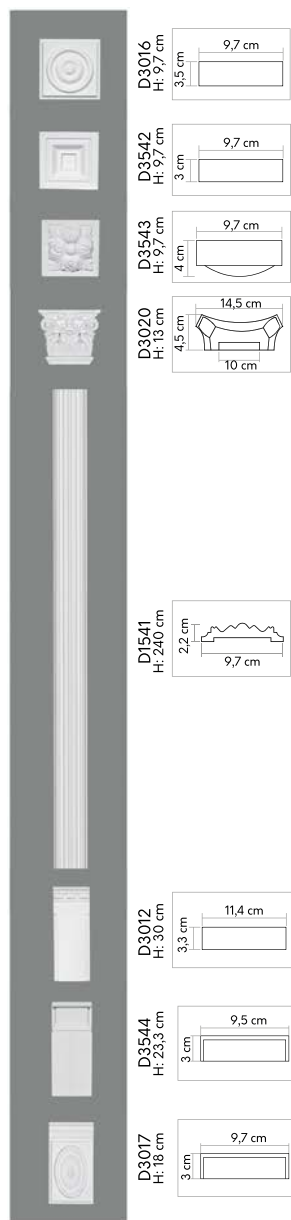

D3016  
H: 9,7 cm  
3,5 cm 9,7 cm

D3542  
H: 9,7 cm  
3 cm 9,7 cm

D3543  
H: 9,7 cm  
4 cm 9,7 cm

D3020  
H: 13 cm  
4,5 cm 14,5 cm  
10 cm

D1541  
H: 240 cm  
2,2 cm 9,7 cm

D3012  
H: 30 cm  
3,3 cm 11,4 cm

D3544  
H: 23,3 cm  
3 cm 9,5 cm

D3017  
H: 16 cm  
3 cm 9,7 cm

ProFoam®

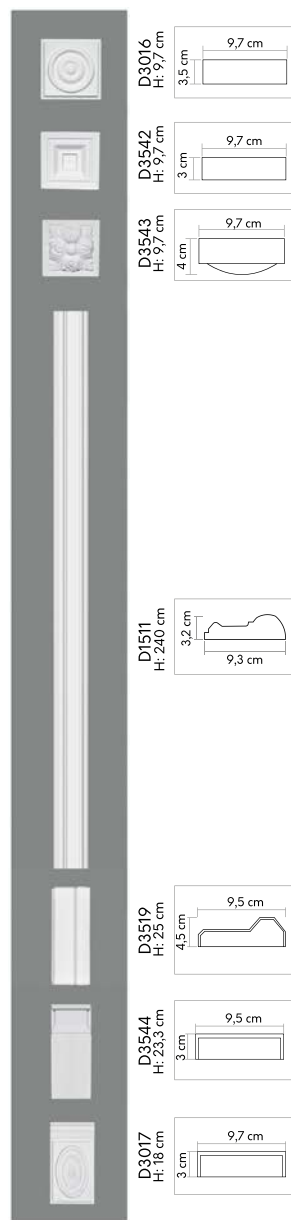

D3016  
H: 9,7 cm  
3,5 cm 9,7 cm

D3542  
H: 9,7 cm  
3 cm 9,7 cm

D3543  
H: 9,7 cm  
4 cm 9,7 cm

D1511  
H: 240 cm  
3,2 cm 9,3 cm

D3519  
H: 25 cm  
4,5 cm 9,5 cm

D3544  
H: 23,3 cm  
3 cm 9,5 cm

D3017  
H: 16 cm  
3 cm 9,7 cm

ProFoam®

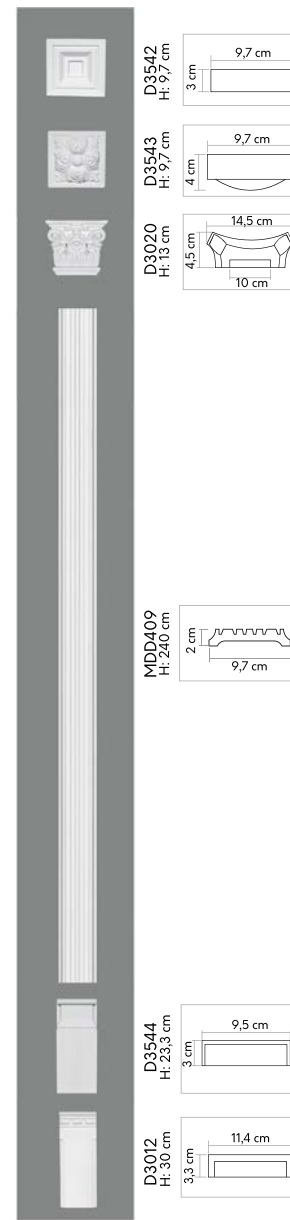

D3542  
H: 9,7 cm  
3 cm 9,7 cm

D3543  
H: 9,7 cm  
4 cm 9,7 cm

D3020  
H: 13 cm  
4,5 cm 14,5 cm  
10 cm

MDB409  
H: 240 cm  
2 cm 9,7 cm

D3544  
H: 23,3 cm  
3 cm 9,5 cm

D3012  
H: 30 cm  
3,3 cm 11,4 cm

ProFoam®

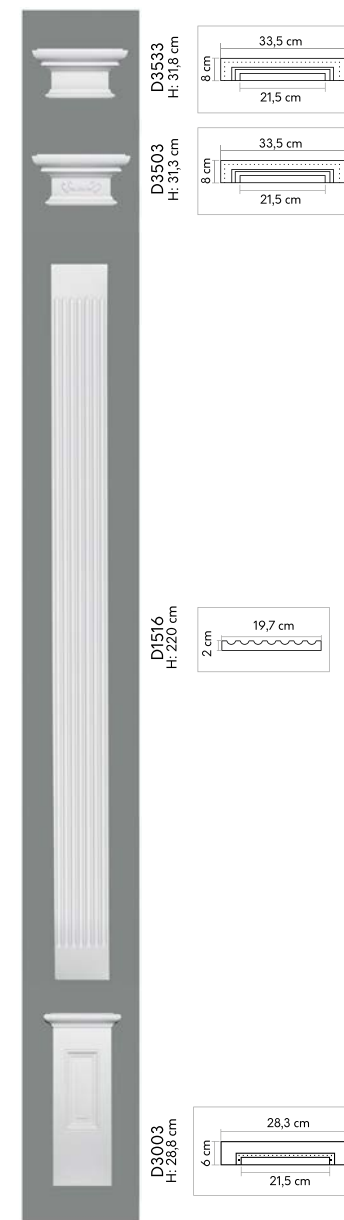

D3533  
H: 31,8 cm  
8 cm 33,5 cm  
21,5 cm

D3503  
H: 31,3 cm  
8 cm 33,5 cm  
21,5 cm

D1516  
H: 220 cm  
2 cm 19,7 cm

D3003  
H: 28,8 cm  
6 cm 28,3 cm  
21,5 cm

ProFoam®

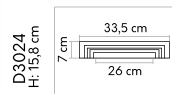
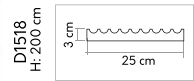
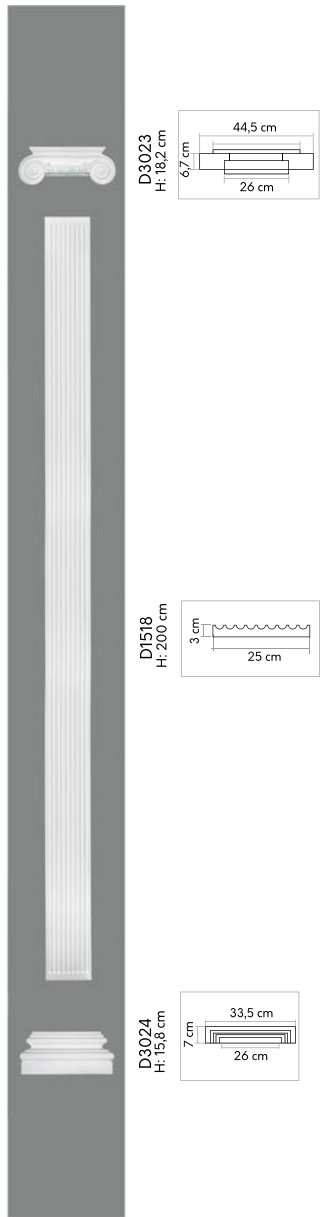

ProFoam®

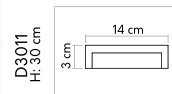
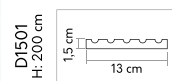
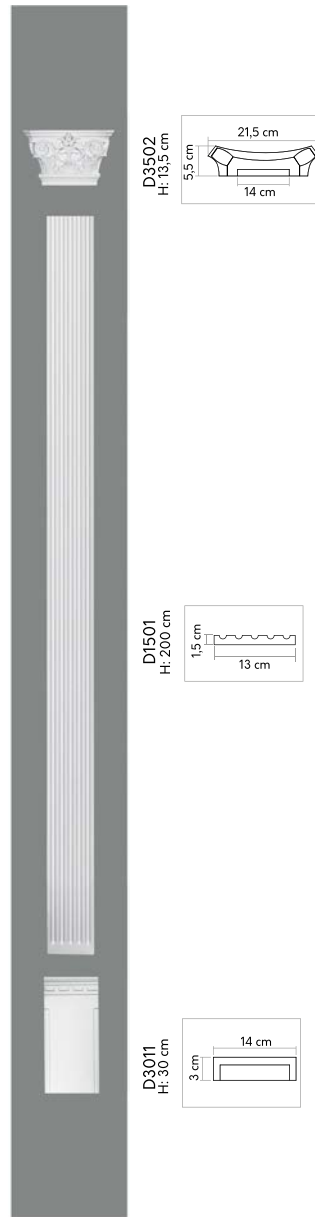

ProFoam®

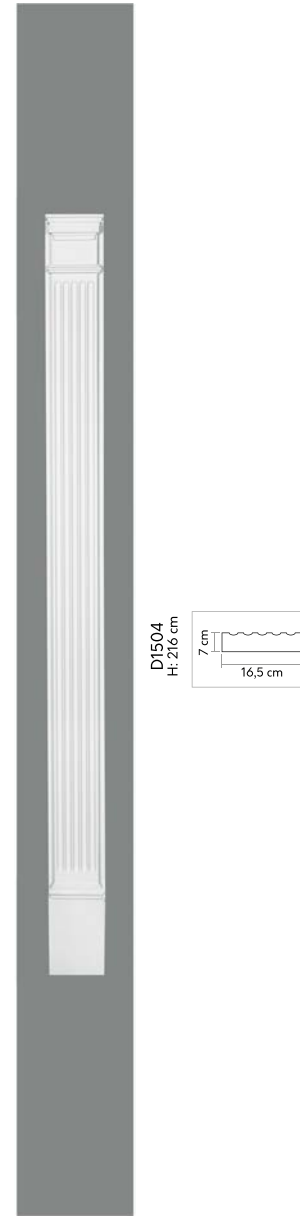

ProFoam®

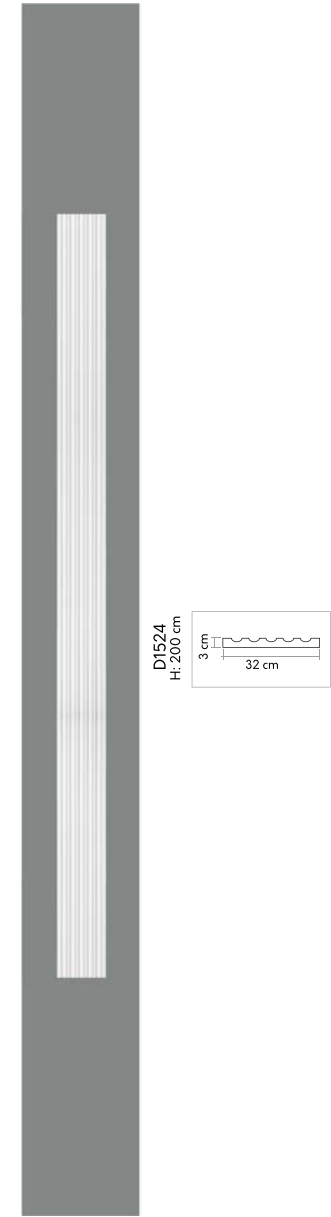

ProFoam®



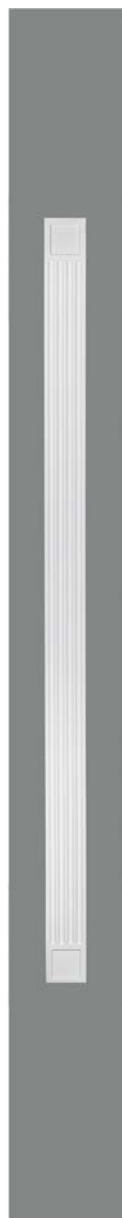

D1500  
Hi: 240 cm

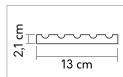

ProFoam®

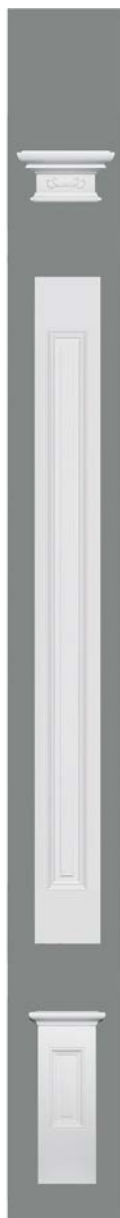

D3503  
Hi: 31,3 cm

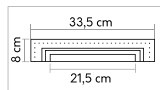

D1515  
Hi: 240 cm

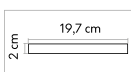

D3003  
Hi: 28,8 cm

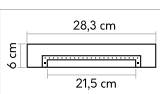

ProFoam®

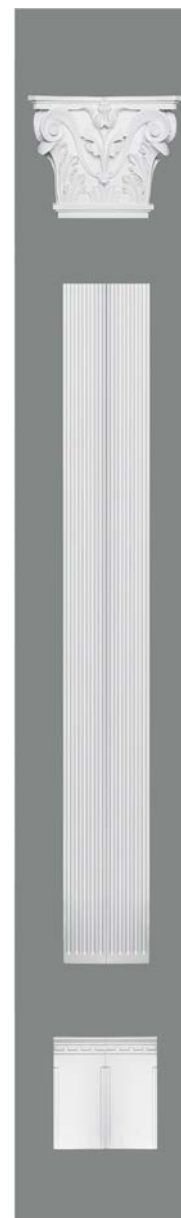

D3505  
Hi: 41,9 cm

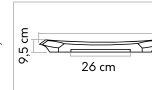

D1501  
Hi: 240 cm

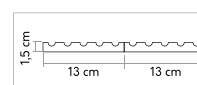

D3011  
Hi: 30 cm

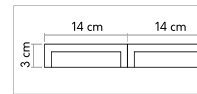

ProFoam®



1

2

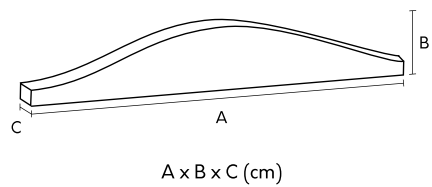

**D2531**  
124/110 x 25 x 8,8/2,3 cm  
ProFoam®

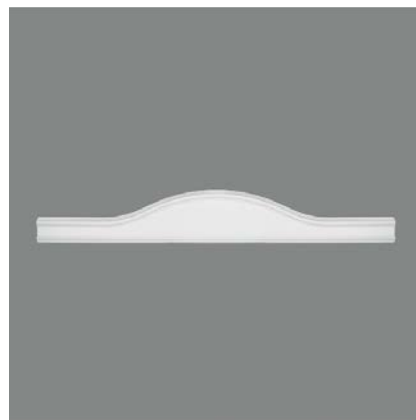

**D2512**  
126 x 19,5 x 3 cm  
ProFoam®



**D3514**  
15,5 x 11,5 x 2 cm  
ProFoam®

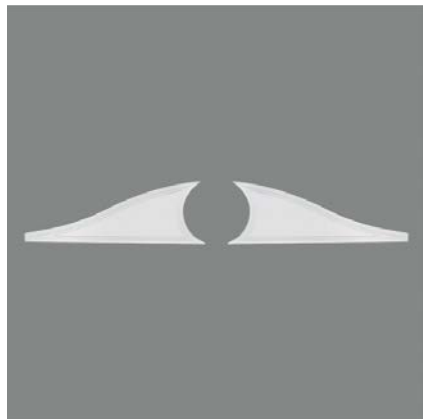

**D3515**  
31,5 x 11 x 0,6 cm  
ProFoam®



**D3516**  
43 x 11 x 1 cm  
ProFoam®



**D3517**  
32 x 13 x 1,5 cm  
ProFoam®



**D3518**  
23 x 13,5 x 3 cm  
ProFoam®

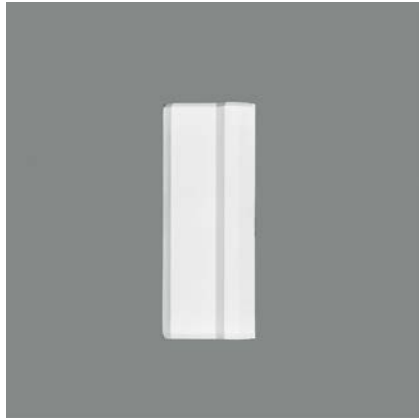

**D3519**  
25 x 9,5 x 4 cm  
ProFoam®



**D3527 (+ D1511)**  
11 x 8,3 x 5 cm  
ProFoam®

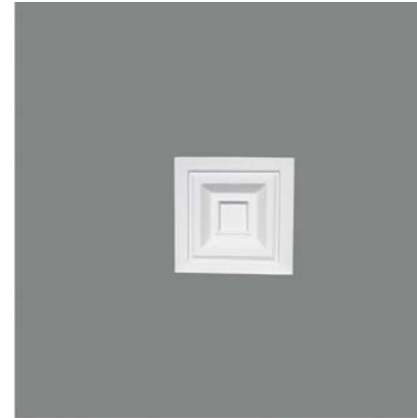

**D3542**  
9,7 x 9,7 x 3 cm  
ProFoam®



**D3543**  
9,7 x 9,7 x 4 cm  
ProFoam®

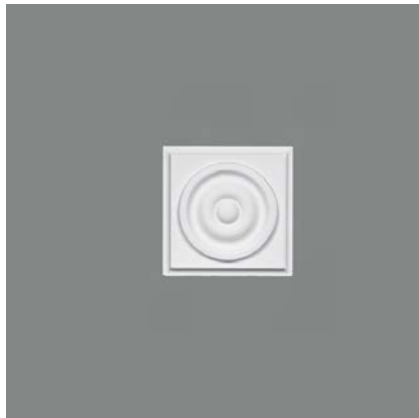

**D3016**  
9,7 x 9,7 x 3,5 cm  
ProFoam®

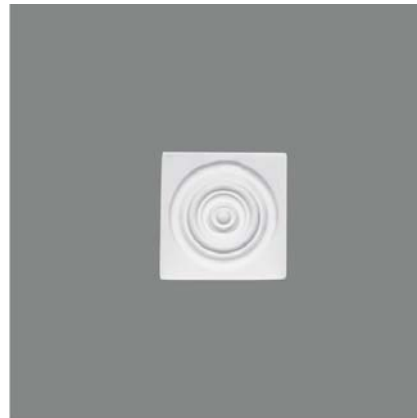

**D5002**  
8,3 x 8,3 x 3 cm  
ProFoam®



**C8031**  
15,6 x 12 x 24,2 cm  
ProFoam®



ProFoam®

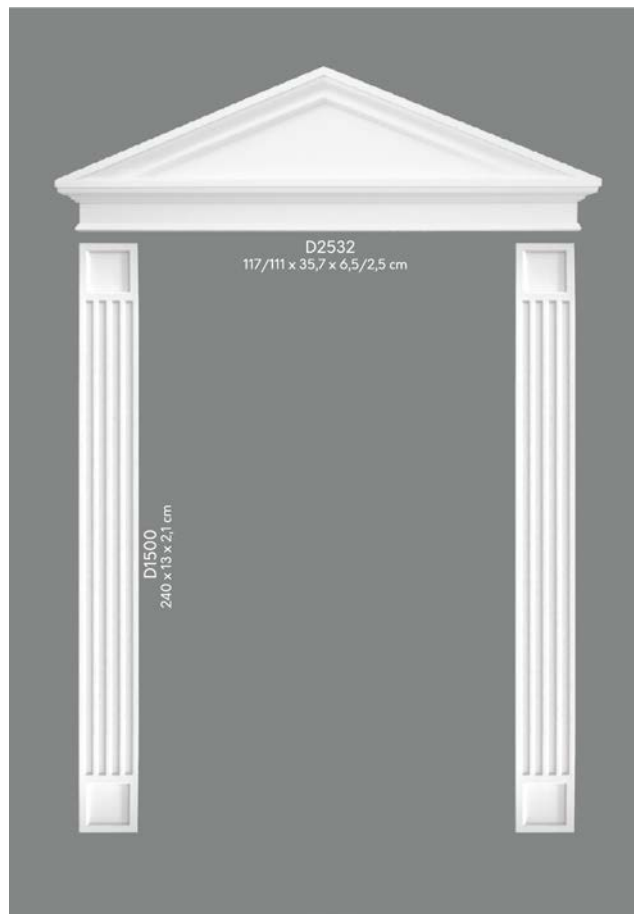

ProFoam®

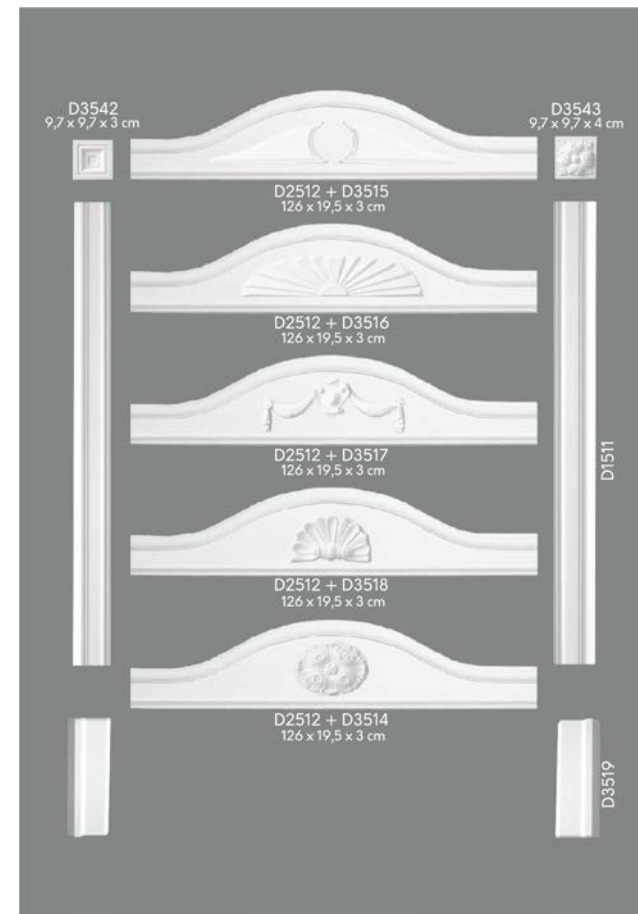

ProFoam®



MD004E  
230 x 4,9 x 1,5 cm  
PolyForce® 



MD359E  
230 x 7 x 1,6 cm  
PolyForce® 



MD018E  
230 x 8 x 1,3 cm  
PolyForce® 



MD258E  
230 x 8,1 x 1,1 cm  
PolyForce® 







5

4

3

2

1

/ Akcesoria  
/ Accessories  
/ Zubehör  
/ Аксессуары



290 ml

## MARDOM **MAX**

PL

Klej hybrydowy o maksymalnej sile wiązania wewnątrz i na zewnątrz pomieszczeń, na powierzchniach porowatych i gładkich. Błyskawiczna szybkość chwytu – już po 8 sekundach. Kolor biały.

DE

Dicht- und Klebstoff auf Hybrid-Polymerbasis. Extrem hohe Haftung im Innen- und Außenbereich, auf rauen und glatten Oberflächen. Die Anfangshaftung nach 8 Sekunden. Weiße Farbe.

EN

Hybrid adhesive with extreme bonding strength indoors and outdoors, on rough and smooth surfaces. Immediate bonding after 8 seconds. White colour.

RU

ГИБРИДНЫЙ ПОЛИМЕРНЫЙ КЛЕЙ-ГЕРМЕТИК. Экстремальная прочность клеевого соединения внутри и снаружи помещений, на пористых и гладких поверхностях. Начальное схватывание через 8 секунд. белый цвет.



300 ml

## MARDOM **FIX PRO**

PL

Klej przeznaczony do montażu sztukaterii wewnętrznej. Charakteryzuje się niezwykle trwałym i mocnym wiązaniem, jest szybkoschnący i bezwonny. Produkt nie zawiera rozpuszczalników. Może być stosowany na różnych powierzchniach (m.in. tynkach mineralnych, płytach kartonowo-gipsowych, drewnie, betonie itd.).

DE

Der Klebstoff ist zur Befestigung von innerem Stab gestaltet. Es wird von extrem haltbarer und starker Bindung gekennzeichnet, ist schnelltrocknend und geruchsneutral. Das Produkt enthält keine Lösungsmittel. Es kann auf verschiedenen Oberflächen (einschließlich mineralischen Putzen, Gipskartonplatten, Holz, Beton etc.) verwendet werden.

EN

An adhesive designed for the installation of interior moldings. It creates extremely durable and strong bonding, and is also fastdrying and odorless. The product does not contain solvents. It can be used on various surfaces (i.e. mineral plasters, plasterboard panels, wood, concrete, etc.).

RU

Клей предназначен для монтажа внутренней штукатурки. Характеризуется необычайно прочным и крепким связыванием, быстро сохнет и без запаха. Продукт не содержит растворителей. Может применяться на различных поверхностях (например, на минеральной штукатурке, гипсокартонных плитах, древесине, бетоне и т.д.).



300 ml

## MARDOM FIX EXTRA

PL

Klej przeznaczony do łączenia i spoinowania sztukaterii Mardom Decor. Oprócz właściwości klejących, pełni też funkcję uszczelniającą łączenia pomiędzy elementami. Produkt nie zawiera rozpuszczalników. Klej zapewnia mocne i trwałe wiązanie. Może być stosowany na różnych powierzchniach (m.in. tynkach mineralnych, płytach kartonowo-gipsowych, drewnie, betonie itd.).

DE

Klebstoff zum Kleben und Verfugen vom Mardom Decor. Zusätzlich zu den Klebeeigenschaften dient er auch zur Dichtung der Verbindung zwischen den Elementen. Das Produkt enthält keine Lösungsmittel. Der Klebstoff bietet eine starke und dauerhafte Verbindung. Es kann auf verschiedenen Oberflächen (einschließlich mineralischen Putzen, Gipskartonplatten, Holz, Beton etc.) verwendet werden

EN

An adhesive designed for bonding and grouting of Mardom Decor mouldings. In addition to its adhesive properties, it also seals the bonds between the elements. The product does not contain solvents. The adhesive provides strong and solid bonding. It can be applied on various surfaces (i.e. mineral plasters, plasterboard panels, wood, concrete, etc.).

RU

Клей предназначен для соединения и закрепления штукатурки Mardom Decor. Кроме клеящих свойств, также он выполняет функцию уплотнителя между элементами. Продукт не содержит растворителей. Клей обеспечивает крепкое и прочное связывание. Может применяться на различных поверхностях (например, на минеральной штукатурке, гипсокартонной плите, древесине, бетоне и т.д.).

## SKRZYŃKA UCIOSOWA / MITER BOX / MITER BOX / СТУСЛО



PL

Skrzynka uciosowa Mardom Decor do przycinania listew pod kątem 45 lub 90 stopni. Wykonana z wysokogatunkowego materiału.

EN

Mardom Decor miter box for cutting mouldings at an angle of 45° or 90°. Made of highgrade material.

DE

Schneidlade Mardom Dekor zum Schneiden von Leisten in einem Winkel von 45 Grad oder 90 Grad. Hergestellt aus hochwertigem Material.

RU

Стусло Mardom Decor для обрезки панелей под углом 45 или 90 градусов. Изготовлено из высококачественного материала.

## TAŚMA ALUMINIOWA / ALUMINUM TAPE / ALUMINIUMBAND / АЛЮМИНИЕВАЯ ЛЕНТА



PL

Taśma aluminiowa służy do montażu listew oświetleniowych. Szerokość: 5 cm.

EN

Aluminum tape, used for the installation of lighting strips. Width: 5 cm.

DE

Das Aluminiumband dient zur Montage von Lichtleisten. Breite: 5 cm.

RU

Алюминиевая лента служит для монтажа осветительных планок. Ширина: 5 см.



SŁUPEK EKSPOZYCYJNY / TOWER  
/ TURM / ДЕКОРАТИВНЫЕ КОЛОННЫ

224 x 80 x 80 cm

ProFoam® PolyForce®



WALIZKA MAŁA / SMALL SAMPLE CASE  
/ KLEINER KOFFER / МАЛЫЙ ЧЕМОДАН

29,5 x 41,5 x 13,5 cm

PolyForce®

WALIZKA DUŻA / BIG SAMPLE CASE  
/ GROßER KOFFER / БОЛЬШОЙ ЧЕМОДАН

41,5 x 56,5 x 16,5 cm

ProFoam®



TABLICA Z LISTWAMI PREMIUM / PREMIUM DISPLAY  
/ PREMIUM ANZEIGETAFEL / PREMIUM ЭКСПОЗИЦИОННАЯ ДОСКА

224 x 80 x 80 cm

PolyForce®





PL

1. Listwy powinny być aklimatyzowane przez około 48 godzin w pomieszczeniu, w którym będą montowane.
2. Przykładamy listwę do rogu sufitu i ściany w pozycji montażowej.

EN

1. The mouldings should be acclimated for approximately 48 hours in the room in which they are installed.
2. Place the moulding in the corner of the ceiling and wall in the desired installation position.

DE

1. Leisten sollten für etwa 48 Stunden im Raum, wo sie installiert werden, akklimatisiert werden.
2. Die Leiste an die Ecke der Decke und der Wand in die Montageposition legen.

RU

1. Панели должны быть акклиматизированы в течение 48 часов в помещении, в котором будут установлены.
2. Прикладываем панель к углу потолка и стены в положении для установки.

PL

3. Obrysujemy dolną i górną krawędź wzdłuż listwy aż do przeciwległej ściany, na której będziemy montowali drugą listwę.
4. Analogicznie postępujemy na drugiej prostopadłej ścianie.

EN

3. Outline the top and bottom edge along the moulding all the way to the opposite wall, where the next moulding will be installed.
4. Repeat the same actions on the perpendicular wall.

DE

3. Die oberen und unteren Kanten entlang der Leiste umreißen, bis der gegenüberliegenden Wand, wo die zweite Leiste montiert werden wird.
4. Ebenso auf der zweiten senkrechten Wand machen.

RU

3. Обрисовываем нижний и верхний край вдоль панели до противоположной стены, на которой будем устанавливать другую панель.
4. Аналогично выполняем действия на другой перпендикулярной стене.

PL

5. Uzyskujemy w ten sposób obrys i linie (kąty) montażu i cięcia listew względem siebie. Dolny punkt linii cięcia listwy znajduje się w samym narożniku tj. w punkcie łączenia dwóch ścian. Górny punkt linii cięcia listwa znajduje się na narysowanym w pkt 3 przecięciu linii krawędzi górnej listew (na suficie) pod kątem 90 stopni.

EN

5. In this way we obtain an outline and the lines (angles) for the installation and cutting of the mouldings in relation to each other. The lower point of the moulding cutting line is located in the corner, that is, at the point where the two walls join. The upper point of the moulding cutting line is located at the point (drawn in point 3) where the lines of the upper edges of the mouldings (on the ceiling) intersect at an angle of 90 degrees.

DE

5. Auf diese Weise haben wir jetzt den Umriss und Leitungen (Winkel) der Montage und Schneiden der Leisten zueinander. Der untere Punkt der geschnittenen Leiste befindet sich in der Ecke, also an der Stelle der Verbindung von zwei Wänden. Der obere Punkt der geschnittenen Leiste befindet sich auf dem im Punkt 3 skizzierten Schnittpunkt der oberen Kante der Leiste (an der Decke) in einem Winkel von 90 Grad.

RU

5. Таким образом, мы получаем контур и линии (углы) монтажа и разреза панелей относительно друг друга. Нижняя точка линии разреза панели находится в самом углу, т.е. в точке соединения двух стен. Верхняя точка линии разреза панели находится на нарисованном в п. 3 пересечения линии верхнего края панелей (на потолке) под углом 90 градусов.





- PL** 6. Cięcia dokonujemy na ukośnicy lub na odpowiednio dużym w stosunku do wysokości listwy korycie uciosowym.
- EN** 6. The cutting is performed on a mitre or a mitre box sufficiently large in relation to the height of the moulding.
- DE** 6. Auf einer Gehrungssäge oder im Bezug auf die Höhe der Leiste ausreichend großen Schneidlade schneiden.
- RU** 6. Отрезаем при помощи торцовочной пилы или на соответственно большом относительно высоты панели стусле.



- PL** 7. Klej Fix Pro nakładamy po długości na lewej stronie profilu w miejscu styku z klejonym podłożem.  
8. Klej nakładamy faliście (ewentualnie liniowo w przypadku niewielkich listew o małej powierzchni klejenia).
- EN** 7. The Fix Pro adhesive is applied along the length on the left side of the profile in the point of contact with the glued surface.  
8. The adhesive is applied in sinuous lines (or in straight lines in the case of small mouldings with small bonding area).
- DE** 7. Klebstoff Fix Pro entlang der Länge auf der linken Seite des Profils an der Kontaktstelle mit der Klebefläche legen.  
8. Klebstoff in der Form einer Welle legen (möglicherweise linear bei kleinen Leisten mit einer kleinen Klebefläche).
- RU** 7. Клей Fix Pro наносим по длине на левой стороне профиля в месте стыка со склеиваемым основанием.  
8. Клей наносим волнами (нанесение линиями - в случае небольших панелей с малой площадью склеивания).



- PL** 9. Listwę mocno dociskamy do podłoża. Zbieramy nadmiar wyciśniętego kleju.
- EN** 9. Firmly press the moulding against the surface. Remove the excess glue that was squeezed out.
- DE** 9. Die Leiste fest gegen den Untergrund drücken. Den überschüssigen Klebstoff entfernen.
- RU** 9. Панель сильно прижимаем к основанию. Собираем излишки вытекшего клея.



- PL** 10. Postępujemy analogicznie w przypadku drugiej ściany. Przykładamy i doklejamy drugi profil, odpowiednio docięty do łączonej listwy.
- EN** 10. Repeat the same actions on the second wall. Place and glue the second profile, properly cut to match the joined moulding.
- DE** 10. Diesen Vorgang für die andere Wand wiederholen. Das zweite Profil, das entsprechend geschnitten und zur Leiste gedrückt wird, legen und kleben.
- RU** 10. Аналогично выполняем действия в случае другой стены. Прикладываем и приклеиваем другой профиль, соответственно срезанный для соединяемой панели.



- PL** 11. Łączenie dwóch listew wypełniamy klejem Fix Extra, dociskając następnie do siebie obie listwy. Nadmiar kleju zbieramy. Po 1-2 godzinach należy skontrolować i ewentualnie zebrać nadmiar kleju Fix Extra (ponieważ potrafi w wyniku reakcji z ProFoam® wypłynąć na wierzch).
- EN** 11. Fill the joint between the two mouldings with Fix Extra adhesive and press both mouldings together. Collect the excess adhesive. After 1-2 hours it is necessary to check and possibly collect excess Fix Extra adhesive (as it can may come out on the surface due to a reaction with ProFoam®).
- DE** 11. Die Verbindung von zwei Leisten mit Fix Extra Kleber füllen, die beiden Leisten zueinander drücken. Überschüssigen Kleber sammeln. Nach 1-2 Stunden überprüfen und gegebenenfalls überschüssigen Fix Extra Kleber sammeln (weil es durch Reaktion mit ProFoam® an der Oberfläche erscheinen kann).
- RU** 11. Соединение двух панелей заполняем клеем Fix Extra, дожидая затем друг к другу обе панели. Излишки клея собираем. Через 1-2 часа следует проконтролировать и собрать излишки клея Fix Extra (поскольку в результате реакции с ProFoam® может вытекать).



- PL** 12. Szczelinę pomiędzy ścianą\sufitem a listwą, oraz pomiędzy dwoma listwami, obrabiamy przy pomocy kleju Fix Pro .Zbieramy nadmiar kleju. Po stwardnieniu klej Fix Pro można szlifować.
- EN** 12. Fill the gap between the wall\ceiling and the moulding, and the gap between the two mouldings with Fix Pro adhesive. Collect the excess adhesive. The Fix Pro adhesive can be grinded once it is cured.
- DE** 12. Der Zwischenraum zwischen der Wand\Decke und Leiste sowie zwischen zwei Leisten, mit Kleber Fix Pro bearbeiten. Überschüssigen Kleber sammeln. Nach dem Aushärten des Klebers Fix Pro kann man mahlen.
- RU** 12. Щель между стеной/потолком и панелью, а также между двумя панелями обрабатываем при помощи клея Fix Pro. Собираем излишки клея. После затвердевания клей Fix Pro можно шлифовать.



- PL** 13. Do końcowego maskowania i wygładzania łączeń można użyć szpachli.
- EN** 13. A putty knife can be used for the final masking and smoothing of the joints.
- DE** 13. Die letzte Tarnung und Glättung der Fugen können mit einem Spachtel durchgeführt werden.
- RU** 13. Для завершающей маскировки разглаживания соединений можно использовать шпатель.



- PL** W przypadku listew podłogowych inox oraz aluminium należy bardzo precyzyjnie dociąć listwę pod kątem 45 stopni. Najlepszym narzędziem jest 14 zębowa piła Mardom Decor.
- EN** In the case of inox (stainless steel) and aluminum skirting boards, the skirting has to be precisely cut at an angle of 45 degrees. Mardom Decor 14-teeth saw is the recommended tool.
- DE** Bei inox- und Aluminium-Bodenleisten muss die Leiste sehr genau auf einem Winkel von 45 Grad geschnitten werden. Das beste Werkzeug ist die Säge Mardom Decor mit 14 Zähnen.
- RU** В случае напольных панелей и из алюминия следует очень точно срезать панель под углом 45 градусов. Лучшим инструментом является 14 зубчатая пила Mardom Decor.



- PL** Odwiedź nas na kanale MARDOM DECOR na youtube.com
- EN** Visit the MARDOM DECOR channel on youtube.com
- DE** Melden Sie sich bei MARDOM DECOR Kanal auf youtube.com an
- RU** Посетите наш сайт MARDOM DECOR на youtube.com

PL

Produkty z kolekcji Mardom Decor Elite oraz Mardom Decor Prestige mogą być montowane na zewnątrz budynków oraz w pomieszczeniach o podwyższonej wilgotności. Konieczne jest wówczas zastosowanie kleju montażowego Mardom Decor Fix Extra. Dodatkowo produkty muszą zostać pokryte farbą zewnętrzną.

Zalecamy sprawdzenie wymiarów produktów przed montażem, ponieważ wartości podane w katalogu mogą nieznacznie odbiegać od rzeczywistości.

Aby zapobiec problemom z montażem, produkty należy aklimatyzować przez 24-48 godzin w pomieszczeniu, w którym będą montowane.

W przypadku niektórych listew oświetleniowych zalecamy użycie aluminiowej taśmy samoprzylepnej.

## GWARANCJA

Na produkty Mardom Decor obowiązuje 12 miesięcy gwarancji pod warunkiem zastosowania klejów sugerowanych przez firmę Mardom Sp. z o.o. oraz spełnienia wszystkich warunków dotyczących instrukcji montażu. Gwarancja nie uwzględnia wad i uszkodzeń spowodowanych niewłaściwym przygotowaniem do instalacji, użytkowaniem lub montażem.

\*\*\*

Wszelkie parametry techniczne oraz atesty na tworzywa PolyForce® oraz ProFoam® dostępne są na stronie [www.mardom-sp.pl](http://www.mardom-sp.pl).

EN

Products from the Mardom Decor Elite and Mardom Decor Prestige collection can be installed outdoors and in areas with increased humidity. It is then necessary to use the Mardom Decor Fix Extra assembly adhesive. In addition, the products must be coated with exterior paint.

We recommend checking the product dimensions prior to installation, because the values given in the catalog may slightly differ from actual measurements.

In order to prevent issues with installation, products should be acclimated for 24-48 hours in the room in which they will be installed.

The application of aluminum foil may be required in some cases of use of the Mardom Decor lighting mouldings.

## GUARANTEE

Mardom Decor products are covered by a 12 month warranty, provided that the customer uses the adhesives suggested by Mardom Sp. z o.o. and all the conditions relating to the installation instructions are met. The warranty does not cover defects and damage resulting from improper preparation for installation, improper use or improper installation.

\*\*\*

All the technical parameters and certificates for the PolyForce® and ProFoam® materials are available on the [www.mardom-sp.pl](http://www.mardom-sp.pl) website.

DE

Die Produkte aus der Sammlung Mardom Decor Elite und Mardom Decor Prestige können im Freien und in Räumen mit hoher Luftfeuchtigkeit installiert werden. Dann ist die Verwendung vom Montagekleber Mardom Decor Fix Extra nötig. Außerdem müssen die Produkte mit Außenfarbe abgedeckt werden.

Wir empfehlen, die Abmessungen des Produkts vor der Installation zu prüfen, da die im Katalog angegebenen Werte geringfügig von der Realität abweichen können.

Um Probleme bei der Installation zu vermeiden, müssen die Produkte für 24-48 Stunden in einem Raum, wo sie zusammengebaut werden, akklimatisiert werden.

In einigen Fällen von der Verwendung von Lichtbändern Mardom Decor kann es notwendig sein, Aluminiumfolie zu verwenden.

## GARANTIE

Für Mardom Decor-Produkte ist eine 12-Monate-Garantie vorausgesetzt, sofern die von der Firma Mardom Sp. z o.o. vorgeschlagen Klebstoffe verwendet und alle Bedingungen für Installationsanweisungen erfüllt werden. Die Garantie umfasst nicht Mängel und Schäden, die durch unsachgemäße Vorbereitung für die Installation, Verwendung oder Montage verursacht werden.

\*\*\*

Alle technischen Spezifikationen und Freigaben von ProFoam®-PolyForce®-Kunststoffen sind auf der Seite [www.mardom-sp.pl](http://www.mardom-sp.pl) verfügbar.

RU

Продукция коллекции Mardom Decor Elite и Mardom Decor Prestige может устанавливаться снаружи зданий и в помещениях с повышенной влажностью. В этом случае необходимо применять монтажный клей Mardom Decor Fix Extra. Дополнительно продукция может быть покрыта наружной краской.

Мы рекомендуем проверять размеры продукции перед монтажом, поскольку значения, указанные в каталоге, могут немного отличаться от реальных.

Чтобы избежать проблем с монтажом, продукцию следует акклиматизировать в течение 24-48 часов в помещении, в котором она будет установлена.

В некоторых случаях использования осветительных панелей Mardom Decor может потребоваться применение алюминиевой фольги.

## ГАРАНТИЯ

На продукцию Mardom Decor действует гарантия 12 месяцев при условии применения клеев, рекомендованных фирмой Mardom Sp. z o.o., а также при выполнении всех условий, касающихся монтажа. Гарантия не учитывает дефекты и повреждения, возникшие по причине несоответствующей подготовки к установке или монтажу.

\*\*\*

Все технические параметры и аттестаты на материалы PolyForce® и ProFoam® доступны на сайте [www.mardom-sp.pl](http://www.mardom-sp.pl).

**B**

|       |    |
|-------|----|
| B2002 | 58 |
| B2003 | 59 |
| B2004 | 59 |
| B2050 | 58 |
| B3002 | 56 |
| B3014 | 56 |
| B3015 | 58 |
| B3016 | 58 |
| B3020 | 57 |
| B3021 | 56 |
| B3023 | 57 |
| B3025 | 57 |
| B3029 | 56 |
| B3030 | 56 |
| B3033 | 56 |
| B3038 | 58 |
| B3047 | 57 |
| B3049 | 58 |
| B3050 | 58 |
| B3077 | 58 |
| B3120 | 57 |

**C**

|          |    |
|----------|----|
| C1000-1H | 62 |
| C1000-2H | 62 |
| C1001-1H | 62 |
| C1001-2H | 62 |
| C1002-1H | 63 |
| C1002-2H | 63 |
| C3000H   | 62 |
| C3001H   | 62 |
| C3002H   | 63 |
| C4000H   | 62 |
| C4001H   | 62 |
| C4002H   | 63 |
| C5000-4H | 62 |
| C5001-4H | 62 |
| C5002-4H | 63 |
| C8031    | 69 |

**D**

|                 |            |
|-----------------|------------|
| D1500           | 66, 70     |
| D1501           | 65, 66     |
| D1504           | 65, 70     |
| D1511           | 64         |
| D1515           | 66         |
| D1516           | 64         |
| D1518           | 65         |
| D1524           | 65         |
| D1541           | 29, 64     |
| D2512           | 68         |
| D2512 + D3514   | 70         |
| D2512 + D3515   | 70         |
| D2512 + D3516   | 70         |
| D2512 + D3518   | 70         |
| D2512 + D3518   | 70         |
| D2531           | 68, 70     |
| D2532           | 70         |
| D3003           | 64, 66     |
| D3011           | 65, 66     |
| D3012           | 64         |
| D3016           | 64, 69     |
| D3017           | 64         |
| D3020           | 64         |
| D3023           | 65         |
| D3024           | 65         |
| D3502           | 65         |
| D3503           | 64, 66     |
| D3505           | 66         |
| D3514           | 68         |
| D3515           | 68         |
| D3516           | 68         |
| D3517           | 68         |
| D3518           | 68         |
| D3519           | 64, 68, 69 |
| D3527 (+ D1511) | 69         |
| D3533           | 64         |
| D3542           | 64, 69, 70 |
| D3543           | 64, 69, 70 |
| D3544           | 64         |
| D5002           | 69         |

**MD**

|         |            |
|---------|------------|
| MD001   | 16         |
| MD002   | 27         |
| MD003   | 26         |
| MD004   | 16         |
| MD004E  | 71         |
| MD005   | 20         |
| MD006   | 19         |
| MD007   | 28         |
| MD008   | 17         |
| MD009   | 19         |
| MD010   | 26         |
| MD011   | 16         |
| MD012   | 26         |
| MD013   | 19         |
| MD014   | 17         |
| MD016   | 18, 29, 50 |
| MD017   | 16         |
| MD017A  | 22         |
| MD017SS | 22         |
| MD018   | 17         |
| MD018E  | 71         |
| MD020   | 21         |
| MD024   | 17, 28, 49 |
| MD025   | 19, 30, 50 |
| MD094   | 18         |
| MD095   | 20         |
| MD105   | 50         |
| MD118   | 49         |
| MD234   | 17         |
| MD234A  | 22         |
| MD234SS | 22         |
| MD235   | 16         |
| MD236   | 18         |
| MD237   | 30         |
| MD255   | 26         |
| MD258   | 17         |
| MD258E  | 71         |
| MD354   | 19         |
| MD355   | 18         |
| MD356   | 20         |
| MD356A  | 22         |
| MD356SS | 22         |
| MD357   | 29         |
| MD358   | 20         |
| MD359   | 16         |
| MD359A  | 22         |
| MD359E  | 71         |

**MDA**

|        |    |
|--------|----|
| MDA002 | 43 |
| MDA005 | 43 |
| MDA007 | 43 |
| MDA008 | 43 |
| MDA040 | 43 |
| MDA046 | 44 |
| MDA067 | 44 |
| MDA072 | 44 |
| MDA098 | 44 |
| MDA106 | 43 |
| MDA109 | 44 |
| MDA113 | 45 |
| MDA121 | 43 |
| MDA138 | 44 |
| MDA212 | 43 |
| MDA218 | 44 |
| MDA401 | 44 |

**MDB**

|        |    |
|--------|----|
| MDB001 | 37 |
| MDB063 | 36 |
| MDB064 | 38 |
| MDB070 | 49 |
| MDB080 | 49 |
| MDB100 | 50 |
| MDB101 | 51 |
| MDB102 | 38 |
| MDB103 | 41 |
| MDB104 | 40 |
| MDB105 | 40 |
| MDB106 | 37 |
| MDB108 | 39 |
| MDB110 | 39 |
| MDB111 | 39 |
| MDB112 | 36 |
| MDB115 | 50 |
| MDB117 | 38 |
| MDB118 | 39 |
| MDB121 | 40 |
| MDB123 | 30 |
| MDB127 | 37 |
| MDB128 | 41 |
| MDB130 | 36 |
| MDB131 | 38 |
| MDB132 | 37 |
| MDB134 | 38 |
| MDB135 | 36 |
| MDB136 | 36 |
| MDB137 | 39 |
| MDB140 | 40 |
| MDB142 | 39 |
| MDB145 | 37 |
| MDB147 | 37 |
| MDB150 | 52 |
| MDB152 | 38 |
| MDB154 | 40 |
| MDB155 | 41 |
| MDB156 | 40 |
| MDB158 | 39 |
| MDB161 | 39 |
| MDB169 | 40 |
| MDB172 | 36 |
| MDB174 | 37 |
| MDB180 | 36 |
| MDB185 | 38 |
| MDB210 | 36 |
| MDB213 | 38 |
| MDB214 | 40 |

**MDC**

|                    |    |
|--------------------|----|
| MDC217             | 33 |
| MDC236             | 33 |
| MDC239             | 33 |
| MDC250             | 33 |
| MDC250-11 + MDC250 | 55 |
| MDC250-12 + MDC250 | 54 |
| MDC252             | 33 |
| MDC252-11 + MDC252 | 55 |
| MDC258             | 33 |
| MDC258-12 + MDC258 | 54 |
| MDC258-13 + MDC258 | 55 |

**MDD**

|                    |    |
|--------------------|----|
| MDD305             | 29 |
| MDD308             | 27 |
| MDD308-11 + MDD308 | 55 |
| MDD308-12 + MDD308 | 54 |
| MDD311             | 28 |
| MDD312             | 26 |
| MDD314             | 27 |
| MDD315             | 30 |
| MDD316             | 26 |
| MDD318             | 26 |
| MDD318-12 + MDD318 | 54 |
| MDD325             | 27 |
| MDD325-12 + MDD325 | 54 |
| MDD332             | 27 |
| MDD332-11 + MDD332 | 55 |
| MDD332-12 + MDD332 | 55 |
| MDD332-13 + MDD332 | 54 |
| MDD334             | 29 |
| MDD335             | 30 |
| MDD338             | 28 |
| MDD339             | 28 |
| MDD345             | 29 |
| MDD346             | 27 |
| MDD351             | 28 |
| MDD356             | 30 |
| MDD409             | 64 |
| MDD410             | 29 |
| MDD412             | 28 |
| MDD413             | 26 |
| MDD414             | 27 |

**Q**

|               |            |
|---------------|------------|
| QC001         | 33         |
| QL001         | 51         |
| QL002         | 50         |
| QL003         | 51         |
| QL004         | 52         |
| QL006         | 27         |
| QL006         | 48         |
| QL007         | 18, 48     |
| QL008         | 21, 48     |
| QL009         | 51         |
| QL010         | 51         |
| QL011         | 12, 51     |
| QL012         | 51         |
| QL013         | 52         |
| QL014         | 20, 48     |
| QL015         | 21, 48     |
| QL016         | 13         |
| QL017         | 29, 48     |
| QL018         | 50         |
| QL019         | 17, 28, 49 |
| QL019 + QL021 | 18, 48     |
| QL020         | 30, 48     |
| QL021         | 16         |
| QL026         | 12         |
| QL036         | 12         |
| QL046         | 12         |
| QL056 new     | 13         |
| QL066 new     | 12         |
| QL076 new     | 12         |
| QL086 new     | 12         |
| QL116         | 12         |
| QR001         | 57         |
| QR002         | 57         |
| QR005         | 57         |
| QS001         | 16         |
| QS002         | 17         |
| QS003         | 20         |
| QS004         | 19         |
| QS007         | 19         |
| QS008         | 21         |
| QS009         | 18         |
| QS010         | 21         |
| QS011         | 20, 30, 51 |











# MARDOM DECOR

MARDOM DECOR  
ul. Ratajska 11a  
91-231 Łódź  
Poland

tel. +48 42 678 67 86  
fax. +48 42 678 67 87

[www.mardomdecor.com](http://www.mardomdecor.com)  
[www.mardom-sp.pl](http://www.mardom-sp.pl)  
[mardomdecor@mardom-sp.pl](mailto:mardomdecor@mardom-sp.pl)

